



INSTRUCTION MANUAL

Model GSD-SDO

GSD-SDO
DC Operator

GSD-R2.4M
Rail for 2.4m Door

GSD-R3.6M
Rail for 3.6m Door

GSD-RKIT
Hardware Kit for
Custom Rail Length
up to 6m

OPERATOR
REQUIRES GRIFCO
MONITORED ENTRAPMENT
PROTECTION



Commercial Sectional Door Operator With Integral Battery Back Up

- THIS OPERATOR IS TO BE INSTALLED AND SERVICED BY A TRAINED TECHNICIAN ONLY
- This operator is compatible with Security+ 2.0[®] accessories

Chamberlain Australia Pty Ltd
Unit 1, 75 Epping Rd North Ryde NSW 2113
Ph: 1800 638 234
www.grifco.com.au

Ref: 01-38727D

GRIFCO[®]

SAFETY SYMBOL AND SIGNAL WORD REVIEW

This commercial door operator has been designed and tested to offer safe service provided it is installed, operated, maintained and tested in strict accordance with the instructions and warnings contained in this manual.



WARNING

Mechanical



WARNING

Electrical

CAUTION

When you see these Safety Symbols and Signal Words on the following pages, they will alert you to the possibility of serious injury or death if you do not comply with the warnings that accompany them. The hazard may come from something mechanical or from electric shock.

When you see this Signal Word on the following pages, it will alert you to the possibility of damage to your commercial door and/or the commercial door operator if you do not comply with the cautionary statements that accompany it.

THESE ARE IMPORTANT SAFETY INSTRUCTIONS. FOLLOW ALL INSTRUCTIONS AS INCORRECT INSTALLATION CAN LEAD TO SEVERE INJURY OR DEATH



Keep commercial door balanced. Sticking or binding doors must be repaired. Commercial doors, door springs, pulleys, brackets and their hardware are under extreme tension and can cause serious personal injury. Do not attempt to loosen, move or adjust them. Call for commercial door service.



Do not wear rings, watches or loose clothing while installing or servicing a commercial door operator.



To avoid serious personal injury from entanglement, remove all ropes connected to the commercial door before installing the door operator.



Installation and wiring must be in compliance with your local building and electrical codes. Connect the power supply cord only to properly earthed mains. If the supply cord is damaged, it must be replaced by the manufacturer, its service agent or similarly qualified persons in order to avoid a hazard.



Moisture and water can destroy the electronic components. Make sure under all circumstances that water moisture or storage moisture cannot penetrate the electronics. The same applies for openings and cable entries.



After the installation a final test of the full function of the system and the full function of the safety devices must be done.



When operating a biased-off switch, make sure that other persons are kept away.



The operator cannot be used with a driven part incorporating a wicket door (unless the operator cannot be operated with the wicket door open).



Motor may become hot during operation. Appropriate clearance and/or shielding should be supplied by the installer to ensure any cabling, wiring and/or other items cannot come in contact with the motor. If temperature rise exceeds 50°C all fixed wiring insulation must be protected, for example, by insulating sleeving having an appropriate temperature rating.



Permanently fasten all supplied labels adjacent to the wall control as a convenient reference and reminder of safe operating procedures.



Disengage all existing commercial door locks to avoid damage to commercial door. Install the wall control (or any additional push buttons) in a location where the commercial door is visible during operation. Do not allow children to operate push button(s) or remote transmitter(s). Serious personal injury from a closing commercial door may result from misuse of the operator.



Activate operator only when the door is in full view, free of obstructions and operator is properly adjusted. No one should enter or leave the building while the door is in motion.



An electrician must disconnect electric power to the commercial door operator before making repairs or removing covers.



The actuating member of a biased-off switch is to be located within direct sight of the door but away from moving parts. Unless it is key operated, it is to be installed at a minimum height of 1500mm and not accessible to the public.



Make sure that people who install, maintain or operate the door follow these instructions. Keep these instructions in a safe place so that you can refer to them quickly when you need to.



This appliance is not intended for use by persons (including children) with reduced physical, sensory or mental capabilities, or lack of experience and knowledge, unless they have been given supervision or instruction concerning use of the appliance by a person responsible for their safety. Children should be supervised to ensure that they do not play with the appliance.



If the operator is installed at a height less than 2.5 metres from floor level or any other level from which the operator can be accessed (eg mezzanine) the installer is responsible to fit guards to the operator to prevent access to the chain drive.



Use the commercial door operator for its intended purpose. The GSD-SDO S-Drive operator is designed lifting spring-balanced sectional doors.



WARNING:

Important safety instructions

It is important for the safety of persons to follow all instructions.

SAVE these instructions

INTRODUCTION

CONTENTS

SAFETY

SAFETY SYMBOL AND SIGNAL WORD REVIEW 2

INTRODUCTION

CARTON INVENTORY 3

OPERATOR SPECIFICATIONS 4

OPERATOR OVERVIEW 5

CONTROL BOARD OVERVIEW 6

EXPANSION BOARD OVERVIEW 7

INSTALLATION

CONNECT RAIL TO OPERATOR 8

MOUNT THE OPERATOR 8

ELECTRICAL CONNECTION AND DOOR ATTACHMENT 9

CONNECT BATTERIES 9

DISCONNECT BATTERIES 9

COMMISSIONING

LIMIT SETTING 10

TYPES OF MONITORED ENTRAPMENT PROTECTION 11

SELECTION OF ENTRAPMENT PROTECTION SYSTEM 11

COMMISSIONING ENTRAPMENT PROTECTION SYSTEMS ... 12

FORCE SETTING AND FINE ADJUSTMENT 13

TYPES OF SECURITY +2.0 TRANSMITTERS 14

COMMISSIONING REMOTE TRANSMITTERS 15

ACCESSORY WIRING 17

CONNECTING ACCESS CONTROL ACCESSORIES 17

CONNECTING EXTERNAL CONTROL DEVICES 17

MISECLLANEOUS WIRING 18

OPERATION

RESET BUTTON 18

OPERATOR ALARM 19

MANUAL DISCONNECT 19

EXPANSION BOARD

AUXILIARY RELAYS 20

WIRING ACCESSORIES TO THE EXPANSION BOARD 21

MAINTENANCE

MAINTENANCE CHART 22

BATTERY MAINTENANCE 22

TROUBLESHOOTING

VIEWING DIAGNOSTIC CODES 23

DIAGNOSTIC CODES CHART 25

CONTROL BOARD LEDS 27

TROUBLESHOOTING CHART 28

SERVICE AND REPAIR PARTS 30

WIRING DIAGRAM

CHAMBERLAIN LIMITED WARRANTY 32

CARTON INVENTORY

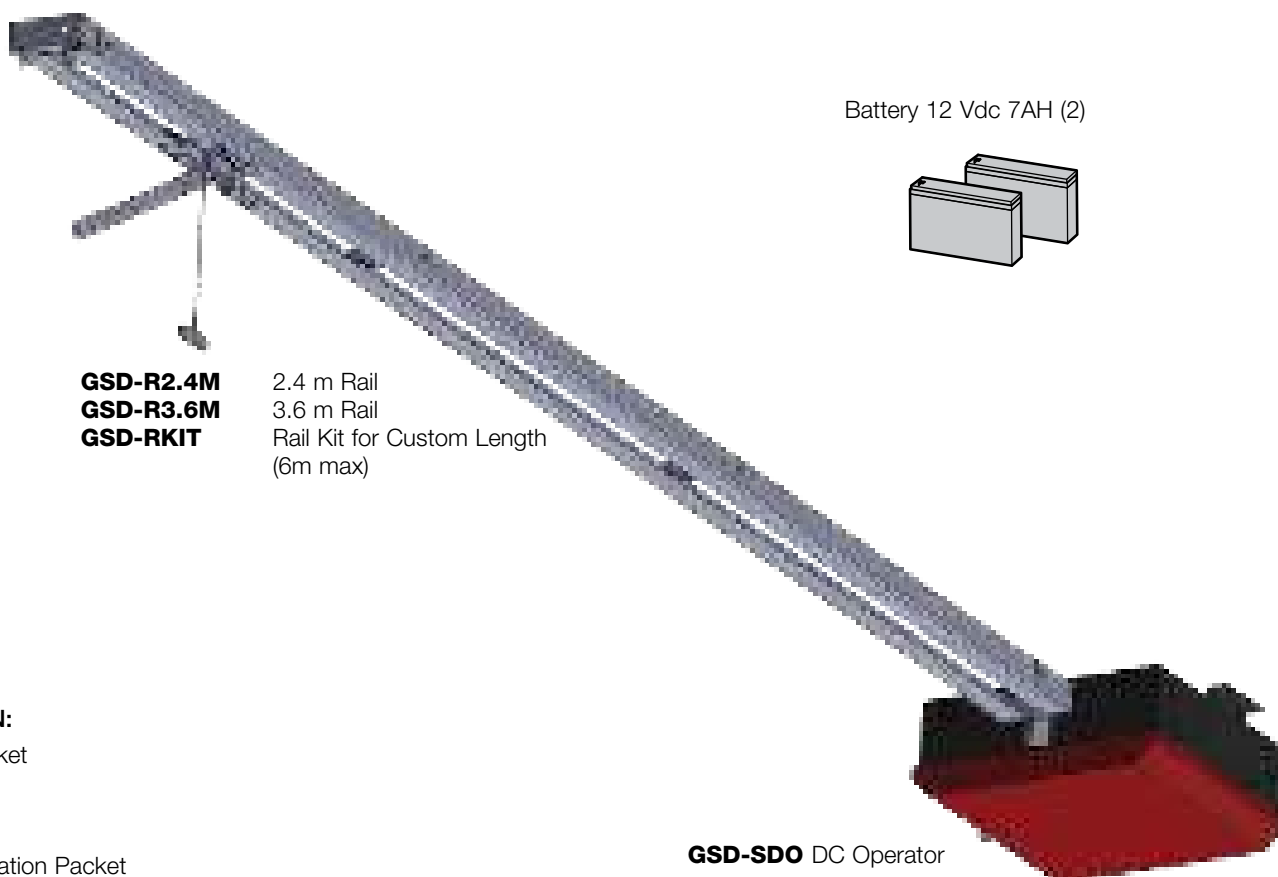

GSD-R2.4M 2.4 m Rail
GSD-R3.6M 3.6 m Rail
GSD-RKIT Rail Kit for Custom Length (6m max)

Battery 12 Vdc 7AH (2)

NOT SHOWN:

- Door Bracket
- J-Bar
- Fasteners
- Documentation Packet
- Chain

GSD-SDO DC Operator

INTRODUCTION

OPERATOR SPECIFICATIONS

Main AC Power Supply	230-240 VAC 50Hz, 400W
Rated Load (R/T)	270N (Continuous)
System Operating Voltage	24 VDC Transformer Run / Battery Backup
Accessory Power	24 VDC, 500 mA max. for ON and SW (switched)
Maximum Door Heights (Rail Part No.)	2.4m (GSD-R2.4M) 3.6m (GSD-R3.6M) 6.0m (GSD-RKIT - rail angle not supplied)
Maximum Door Weight	315.5 kg balanced door
Maximum Door Area	26m ²
Travel Speed	20cm per second
Maximum Duty Cycle	Continuous
Operating Temperature	+5°C to +40°C
Expansion Board	Included
Compliance	AS/NZS 60335-1 AS/NZS 60335-2-103
Usage	Indoor Use Only

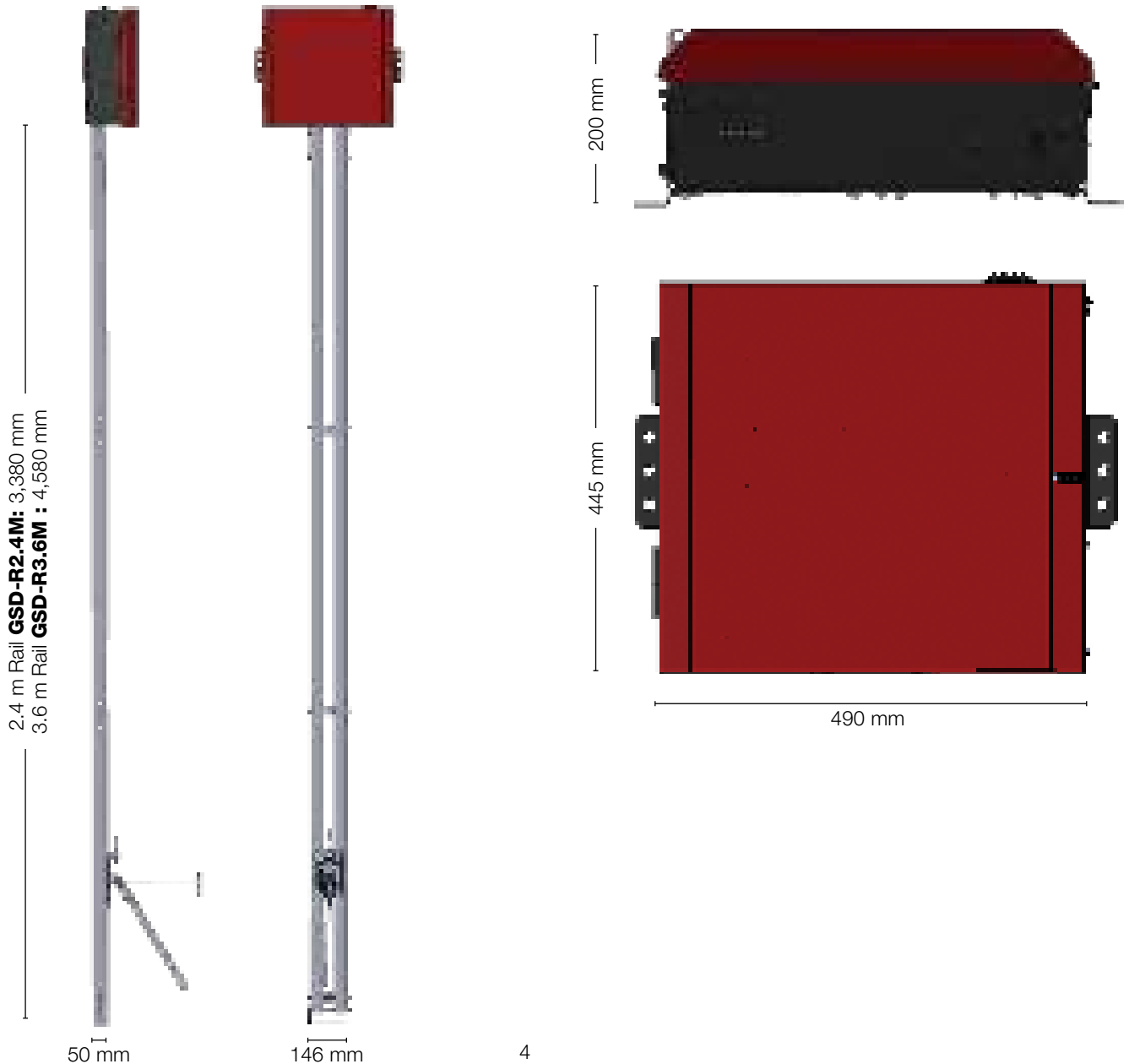

INTRODUCTION

OPERATOR OVERVIEW

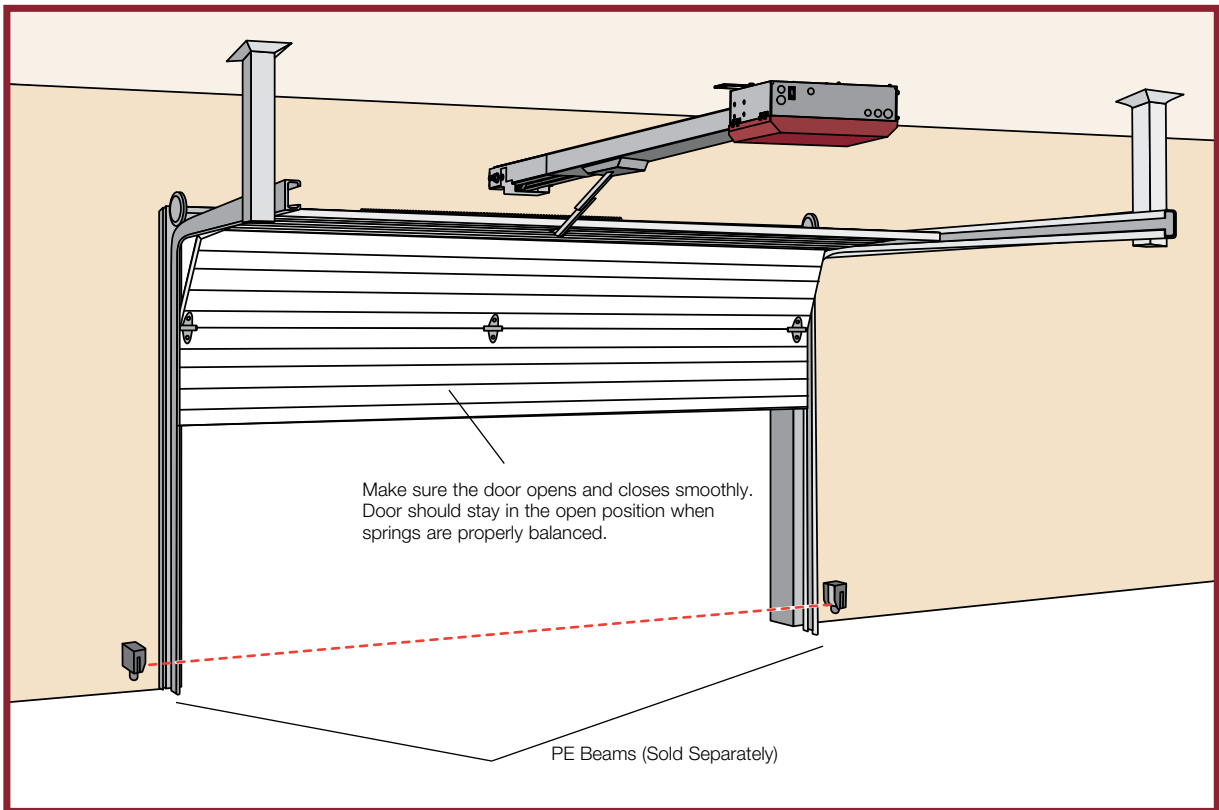
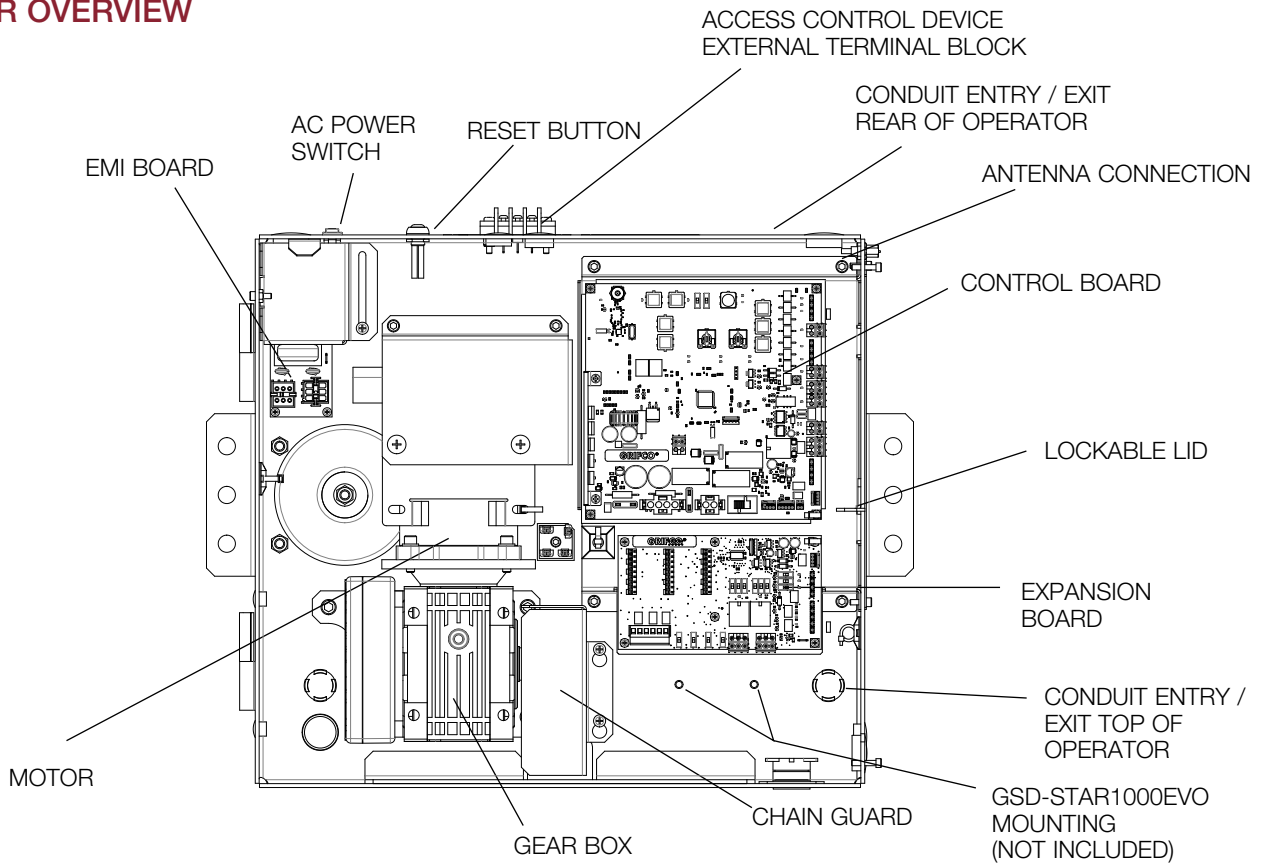

WARNING



Always wear protective gloves and eye protection when changing the battery or working around the battery compartment.

INTRODUCTION

CONTROL BOARD OVERVIEW

1. **SET OPEN Button:** The SET OPEN button sets the OPEN limit. See Adjust Limits section
 2. **SET CLOSE Button:** The SET CLOSE button sets the CLOSE limit. See Adjust Limits section.
 3. **MOVE GATE Buttons:** The MOVE GATE buttons will either open or close the door when the operator is in Limit setting mode. See Adjust Limits section
 4. **BATT FAIL:**
 - When AC power is OFF and battery voltage is critically low the door will latch at a limit until AC power is restored or Batteries voltage increases
 - Option select switch set to OPEN forces door to automatically open and then latch at the OPEN limit until AC power is restored or battery voltage increases
 - Option select switch set to CLOSE forces door to latch at CLOSE limit if at CLOSE limit or on next CLOSE Command until AC power restored or battery voltage increases
 - Constant pressure on a hard command input overrides to open or close the gate/door
 - Critically low battery is less than 23V
 5. **BIPART DELAY Switch:** Not used in this application, ensure switch remains in OFF position
 6. **LEARN Button:** The LEARN button is for programming remote transmitters and the network.
 7. **TIMER-TO-CLOSE dial:** The TIMER-TO-CLOSE (TTC) dial can be set to automatically close the door after a specified time period. The TTC is factory set to OFF. If the TTC is set to the OFF position, then the door will remain open until the operator receives another command from a control. Rotate the TIMER-TO-CLOSE dial to the desired setting. The range is 0 to 180 seconds, 0 seconds is OFF
- NOTE: Any radio command, single button control, or CLOSE command on the control board prior to the TTC expiring will close the door. The TTC is reset by any signals from the open controls, loops, close edges, and close photoelectric sensors (IR's)
8. **REVERSAL FORCE dial:** The REVERSAL FORCE dial adjusts the force. See Force Adjustment section
 9. **TEST BUTTONS:** The TEST BUTTONS will operate the door (OPEN, STOP and CLOSE)
 10. **STATUS LEDs:** The STATUS LEDs indicate the status of the operator. See Status LED Chart in the Troubleshooting section
 11. **Diagnostic Code Display:** The diagnostic code display will show the operator type, firmware version, and diagnostic codes. The operator type will display as "Gd" followed by a "24" which indicates the operator type as GSD-SDO. The firmware version will show after the operator type, example "1.2"
 12. **BACKDRIVE Switch:** MUST BE set to SECURE

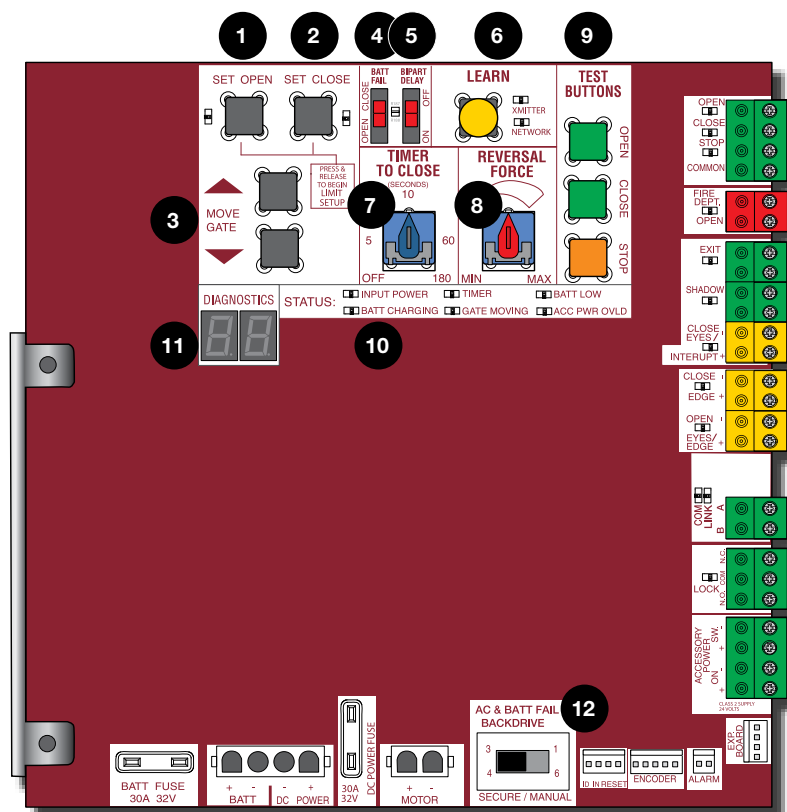

INTRODUCTION

EXPANSION BOARD OVERVIEW

1 QUICK CLOSE Switch:

OFF: No change to the door's normal operation.

ON: When CLOSE EYES/Interrupt loop is deactivated it causes an opening or a stopped door to close (ignores the Timer-to-Close).

2 AC FAIL Switch:

OPEN: Loss of AC power will cause the door to open approximately 15 seconds after AC power fail and remain OPEN until AC power is restored (enabling the Timer-to-Close).

BATT: With loss of AC power, door will remain in present position and operator is powered from batteries.

3 EXIT LOOP FAIL Switch:

OPEN: if the EXIT plug-in loop detector detects a fault, then the door will open and remain open until fault is cleared.

CLOSE: The plug-in EXIT loop detector faults are ignored (EXIT loop is faulted and inoperative)

4 ANTI-TAIL Switch:

OFF: When CLOSE EYES/Interrupt loop is activated it causes a closing door to stop and reverse.

ON: When CLOSE EYES/Interrupt loop is activated it causes a closing door to pause. Once the vehicle is clear the door will continue to close.

5 **AUX RELAY Switches:** Set the AUX RELAY switches as needed to obtain the desired function as shown on pages 20-21.

6 **EYE/EDGE Switches:** Set the EYE/EDGE switches as needed to obtain the desired OPEN or CLOSE functionality.

7 **1, 2, and 3 LEDs:** LEDs indicating the status of the EYE/EDGE inputs. Also used to check the firmware version of the expansion board:

1. Locate the 1, 2, and 3 LEDs on the expansion board.

2. Disconnect AC/DC power to the main control board for 15 seconds.

3. Connect power. The 1, 2, and 3 LEDs will flash in sequence until the main control board firmware revision is displayed. When the green POWER LED glows solid the LED 1 will flash the version number, then stop, then the LED 2 will flash the revision number (for example: For version 5.1 when the green POWER LED is solid the LED 1 will flash 5 times, then stop, then the LED 2 will flash once).

8 **MAIN BOARD Input:** Input Connection for the main board connector.

9 **Input LEDs:** LEDs indicating the status of the SBC, OPN, CLS, and STP inputs.

10 **Loop Detector Inputs:** Inputs for the Plug-In Loop Detectors

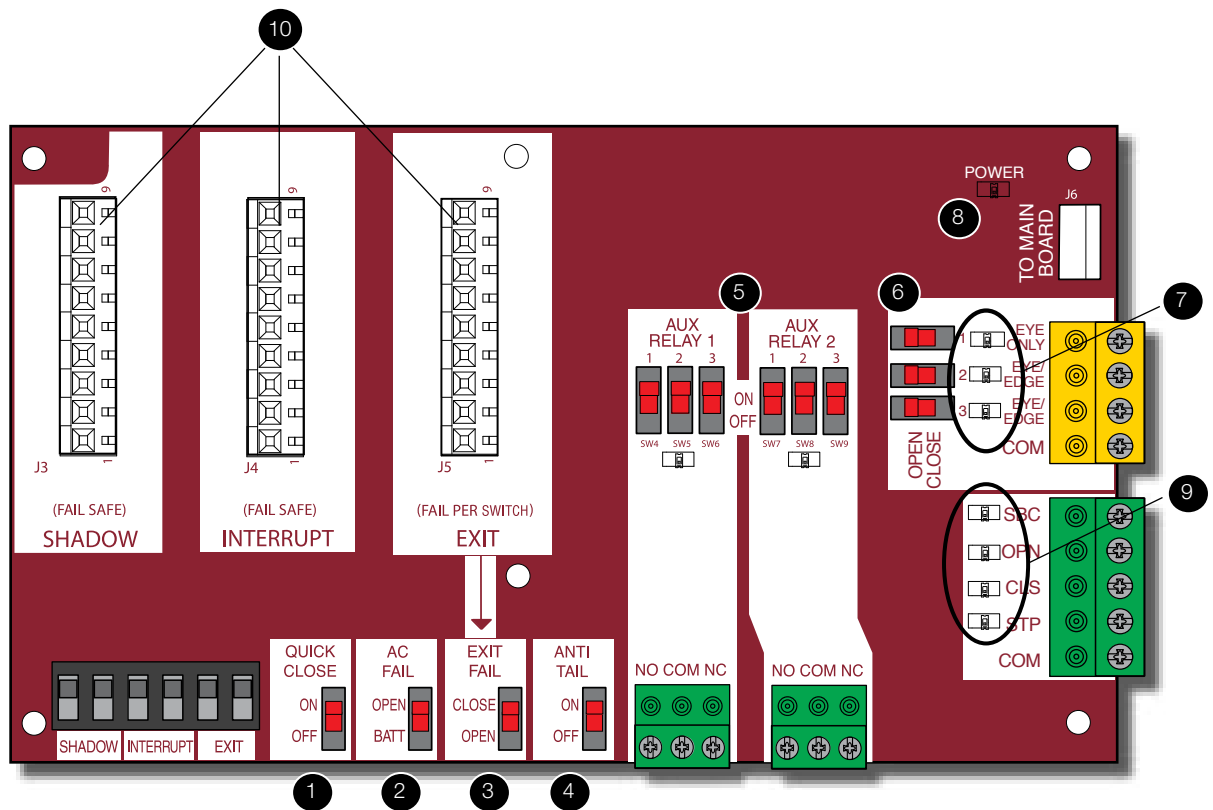

WARNING

To AVOID damaging the circuit board, relays or accessories, DO NOT connect more than 42 Vdc (32 Vac) to the AUX relay contact terminal blocks.

INSTALLATION

BEFORE INSTALLATION, ENSURE THE OPERATOR IS SUITABLE FOR THE TYPE AND SIZE OF THE DOOR. ENSURE THE TEMPERATURE RANGE MARKED ON THE OPERATOR IS SUITABLE FOR THE LOCATION OF THE INSTALLATION. ENSURE THAT THE DRIVEN PART IS IN GOOD MECHANICAL CONDITION, CORRECTLY BALANCED AND OPENS AND CLOSSES PROPERLY.

STEP 1

CONNECT RAIL TO OPERATOR

1. Position the operator and rail as shown below
2. Open the cover and remove the chain guard
3. Secure the rail to the operator with the square-neck bolts and Nylock nuts provided.
NOTE - Do not use washers with these nuts
4. Cut the cable ties securing the chain
(The trolley should be approximately 1m from the end of the rail)
5. Remove tensioner nut (shown as (6) below) and wrap the chain around the output sprocket
6. Reconnect the tensioner nut and tighten until chain hangs approx 10mm below horizontal
7. Replace chain guard

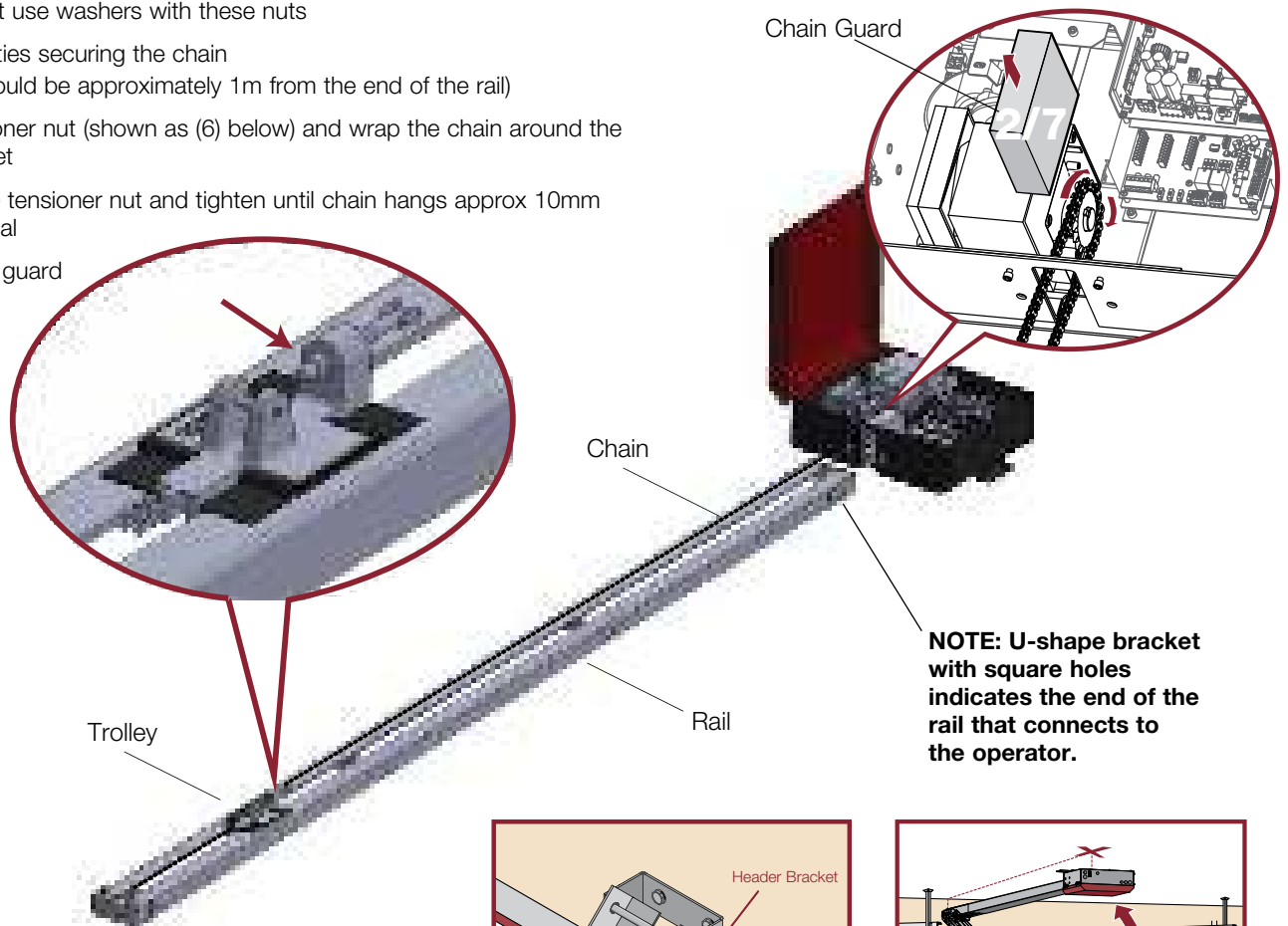

STEP 2

MOUNT THE OPERATOR

1. With the door closed, mark the centre of the door on the wall above the door
2. Open the door and mark the centre of the door on the ceiling. Ensure height of the rail has the correct clearance with the door in the open position (see diagram right)
3. Close the door, mount the header bracket and rail assembly to the wall. Make sure the header bracket is in the centre of the door opening
4. Lift the operator and align with the centre mark on the ceiling. Temporarily support the operator
5. Attach operator to ceiling using lateral mounting brackets. Ensure at least 1 fixing on either side of the operator
6. Attach the door bracket to the door
7. Attach the push arm to the trolley, test emergency release rope is operational. Attach the J-bar to the push arm
8. Attached J-bar to door bracket after following STEP 3 on the next page

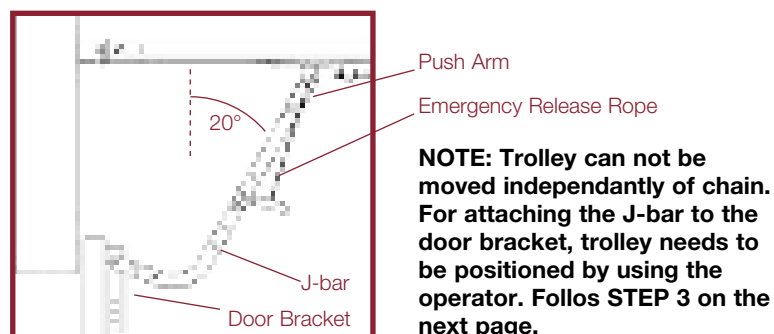
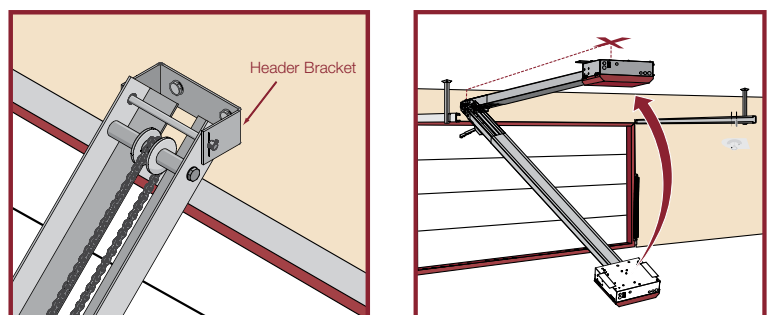

NOTE: Lateral mounting plates are provided with multiple holes. Alternate holes to the installation can be used to temporarily suspend the operator (with ropes, hooks etc not provided) during mounting.

INSTALLATION

STEP 3

ELECTRICAL CONNECTION AND DOOR ATTACHMENT

Connect the operator to the mains power supply using the pre-connected mains plug to a 10A general power outlet

NOTE: After electrical connection, J-bar can be attached to door bracket by activating the operator. Press the "MOVE GATE" buttons to position the trolley / J-bar assembly so it can be attached to the door bracket. Push arm should be approx 20° from vertical

STEP 4

CONNECT BATTERIES



The batteries are charged in the circuit by the integrated transformer. The batteries are for battery backup

1. **SEE WARNING!** Unplug the J15 plug labelled BATT on the control board by squeezing the plug and pulling it from the control board. This disconnects the ac/dc power to the control board
2. Loosen the screws on the battery cover and rotate out of the way
3. Connect the red wire to the positive (+) terminal on one battery and connect the black wire to the negative (-) terminal on the other battery
4. Connect the black jumper (included with the batteries) between the positive (+) terminal of one battery to the negative (-) terminal of the other battery
5. Insert the batteries as shown
6. Reattach the battery cover
7. Insert the J15 plug back into the control board. This will power up the control board. NOTE: You may see a small spark when plugging the J15 plug into the board
8. Turn ON AC power at the wall switch
9. Turn ON the AC power switch on the rear of the operator

NOTE: Batteries are supplied fully charged. They are automatically charged when operator is connected to mains power.

DISCONNECTING BATTERIES

1. Turn OFF the AC power switch on the rear of the operator
2. Turn OFF the power at the wall switch
3. **SEE WARNING** Remove the J15 plug from the control board
4. Loosen the screws on the battery cover and rotate out of the way
5. Carefully remove batteries and disconnect all wires from the battery terminals
6. Dispose of used batteries responsibly
7. Follow instructions above to connect new batteries

OPERATOR WILL NOT FUNCTION WITHOUT GRIFCO BATTERIES CONNECTED

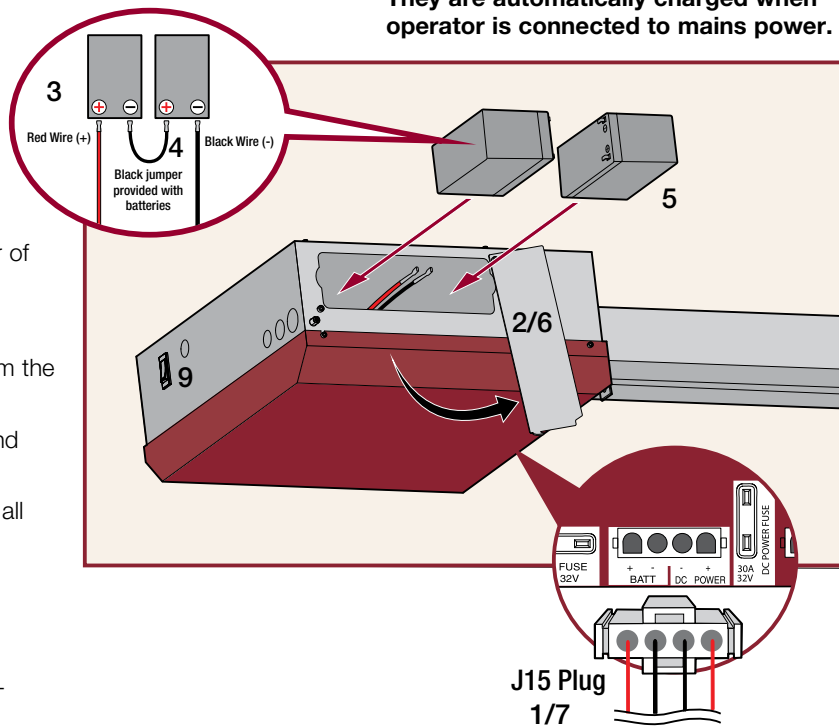

Batteries are supplied charged. When batteries are connected the operator is fully functional without AC power connected.

COMMISSIONING

LIMIT SETTING

INTRODUCTION

Your operator is designed with electronic controls to make travel limit and force adjustments easy. The adjustments allow you to program where the door will stop in the open and close position. The electronic controls sense the amount of force required to open and close the door.

The force is adjusted automatically when you program the limits but can be fine tuned using the REVERSAL FORCE dial on the control board (refer to Fine Tune the Force section) to compensate for environmental changes.

The limit setup LEDs (located next to the SET OPEN and SET CLOSE buttons) indicate the status of the limits, refer to the table below.

LIMIT SETUP LEDS			
SET OPEN LED	SET CLOSE LED	OPERATOR MODE	EXPLANATION
OFF	OFF	NORMAL MODE	Limits are set
BLINKING	BLINKING	LIMIT SETTING MODE	Limits are not set
BLINKING	ON	LIMIT SETTING MODE	Open limit is not set
ON	BLINKING	LIMIT SETTING MODE	Close limit is not set
ON	ON	LIMIT SETTING MODE	Limits are set

The limits can be set using the control board (below) or a remote transmitter (refer to Limit Setup with a Remote Transmitter in the Programming section). Setting the limits with a remote transmitter requires a 3-button transmitter programmed to OPEN, CLOSE, and STOP.

NOTE: The Test Buttons on the control board will not work until the limits have been set.

The door MUST be attached to the operator before setting the limits and force.

1. Press and release the SET OPEN and SET CLOSE buttons simultaneously to enter limit setting mode
2. Press and hold one of the MOVE GATE buttons to move the door to the open or close limit
3. Press and release the SET CLOSE or SET OPEN button depending on which limit is being set
4. Press and hold one of the MOVE GATE button to move the door to the other limit
5. Press and release the SET CLOSE or SET OPEN button depending on which limit is being set
6. Cycle the door open and close by pressing the green "TEST BUTTONS" (Open and Close). This automatically sets the force

When limits are set properly the operator will automatically exit limit setting mode.

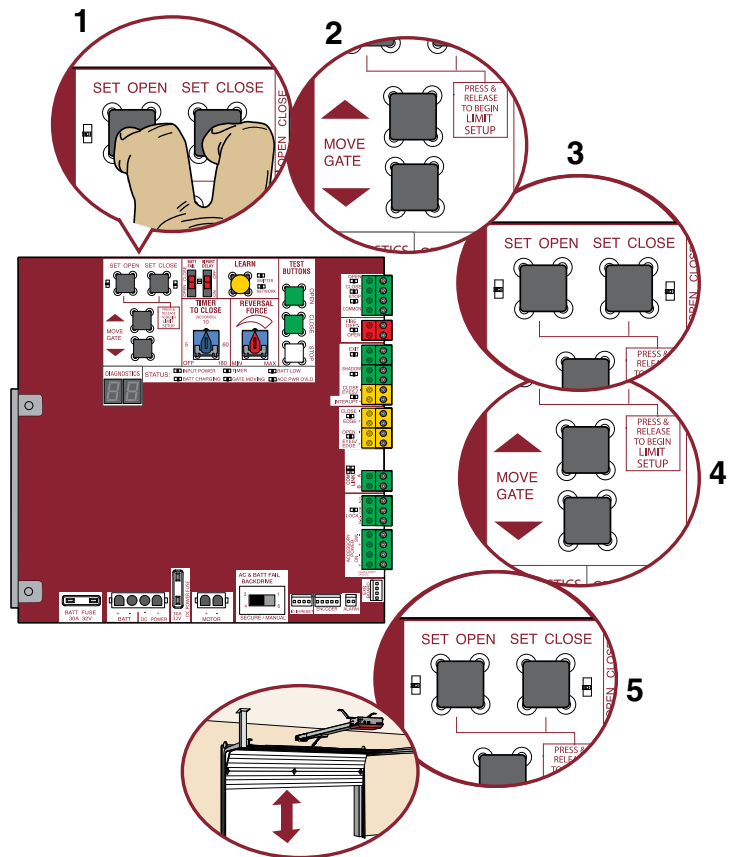

WARNING

- NEVER increase force beyond minimum amount required to move door.
- NEVER use force adjustments to compensate for a binding or sticking door.
- If one control (force or travel limits) is adjusted, the other control may also need adjustment.

TYPES OF MONITORED ENTRAPMENT PROTECTION

A monitored safety device requires a dedicated control system to actively supervise the state of the safety sensor to ensure that any kind of sensor failure will be detected, preventing the door from operating unsafely. Non-compliant safety sensors, relying on a

non-monitored, normally-closed contact, can be bypassed or fail to operate in the event of damage or tampering. Entrapment Protection Systems must be monitored to form part of a compliant system.



MONITORED LIGHT CURTAIN

The Grifco Light Curtain offers the ultimate in superior safety. Regardless of the application, the multiple angled light beams create a field of entrapment protection ensuring unsupervised closing doors operate in a safe manner.

Part No.	GLCPS
Description	Grifco Light Curtain Protector System - plug-in monitored send/receive light curtain (Inc light curtains, mount system & cable)



MONITORED REFLECTIVE SAFETY BEAM KIT

When utilised as part of a Monitored Entrapment Protection System, these beams offer exceptional safety for auto-closing doors. If an obstruction is detected the door will stop and reverse. The reflective beam requires wiring to only one side of the door opening.

Part No.	GPS15	Plug-in monitored Reflective Beam For door widths up to 15m
----------	--------------	--

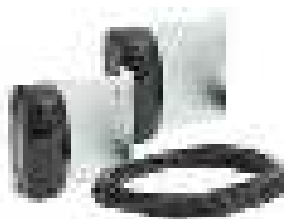

MONITORED SEND / RECEIVE SAFETY BEAM KIT

Send / Receive beams are ideal for emergency services facilities. Wiring is required down both sides of the door opening.

Part No.	GPS772	Plug-in monitored Send / Receive Beam For door widths up to 15m
----------	---------------	--

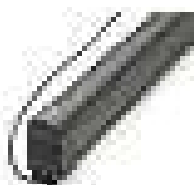

MONITORED SAFETY EDGE

Safety edge is mounted to the bottom of the door and detects obstructions upon contact.

Part No.	BMSE30K (other lengths available)	Wired safety edge 3,000mm
----------	--	---------------------------

SELECTION OF ENTRAPMENT PROTECTION SYSTEM

This operator provides a range of open and close automation options and therefore entrapment protection devices must be fitted to ensure compliance to the relevant standard (AS/NZS 60335-2-103).

Methods used to provide safety and compliance are determined by the functional requirements of the installation and the door type. It is the responsibility of the installer to ensure the installation meets the requirements of AS/NZS 60335-2-103.

GRIFCO offers a range of entrapment protection devices including Safety Beams, Light Curtains, and Safety Edges. An example sectional door installation using GRIFCO entrapment protection devices is shown right.

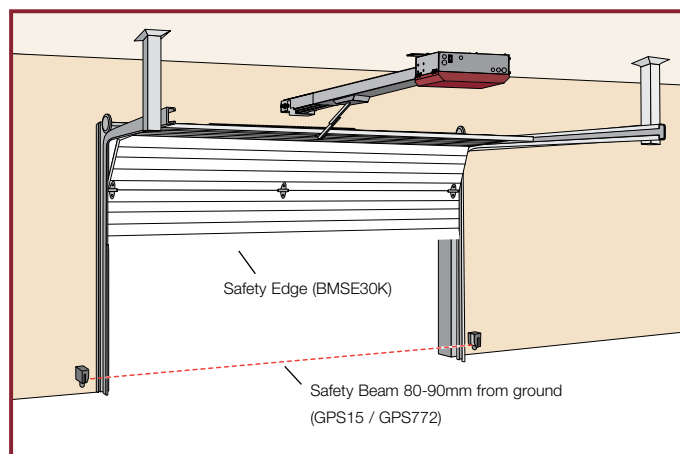

NOTE: Where a grill type door is installed with openings ≥ 50 mm protection in the opening direction is required. This can be achieved with the installation of a monitored safety beam mounted on the outside of the door to protect against entrapment protection / collision with the door lintel. GRIFCO monitored Safety Beams must be used to provide protection.

For applications with no monitored entrapment protection, the operator can be controlled using the on-board "OPEN / CLOSE / STOP" inputs with the use of a hold-to-close push button accessory. See page 18 for installation instructions.

COMMISSIONING ENTRAPMENT PROTECTION SYSTEMS

CONTROL BOARD

CLOSE EYES (Infrared Safety Beams)

The CLOSE EYES/INTERRUPT input is for PE beam entrapment protection in the CLOSING direction. When an obstruction is detected during closing, the door will stop and open to the fully open position. Timer to close will be reset. This input will be disregarded during opening.

CLOSE EDGE (Safety or Bump Edge)

The CLOSE EDGE input is for monitored (8K2) contact edge sensor entrapment protection for the close direction. When an obstruction is detected during closing, the door will stop and open to the fully open position. Timer to close will be disabled after a second obstruction is detected. This input will be disregarded during opening.

OPEN EYES/EDGE

The OPEN EYES/EDGE input is for PE beams or contact edge sensor entrapment protection for the open direction. When an obstruction is detected during opening, the door will stop and travel down for 2 seconds. This input will be disregarded during closing.

Open Eyes / Edges can be used on doors that may present an entrapment danger in the opening direction.

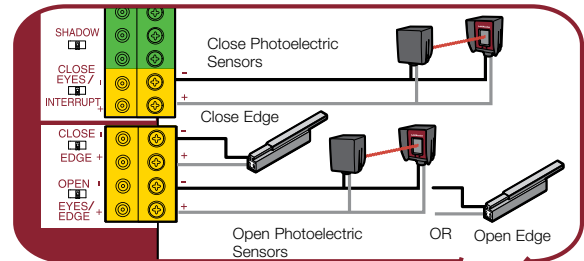
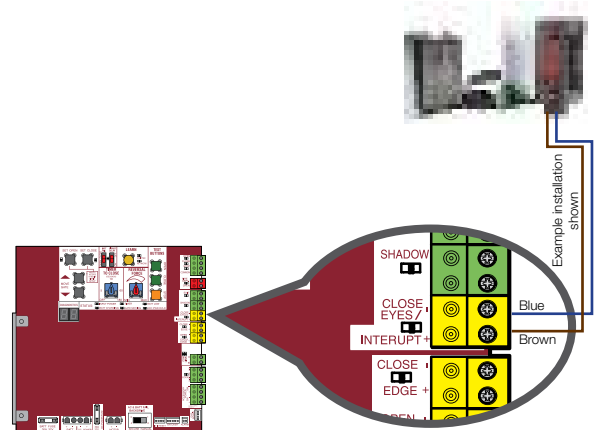

TO REMOVE AND ERASE MONITORED ENTRAPMENT PROTECTION DEVICES

1. Remove the entrapment protection device wires from the terminal block.
2. Press and release the SET OPEN and SET CLOSE buttons simultaneously. The SET OPEN and SET CLOSE LEDs will turn on (entering learn limit mode).
3. Press and release both SET OPEN and SET CLOSE buttons again to turn off the SET OPEN and SET CLOSE LEDs (exiting learn limit mode).

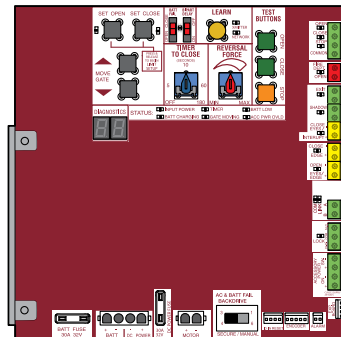

EXPANSION BOARD

EYE ONLY and COM

Open or Close direction PE beams with selectable functionality.

EYE/EDGE and COM (x2)

Open or Close direction PE Beams OR contact edge sensors with selectable functionality.

DIP SWITCH SETTINGS

The DIP Switches located next to the terminals have the following functions:

Set to Close:

The door will stop and reverse to open when an obstruction is detected.

Set to Open:

The door will stop and retract when an obstruction is detected.

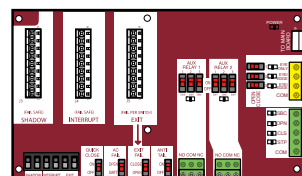
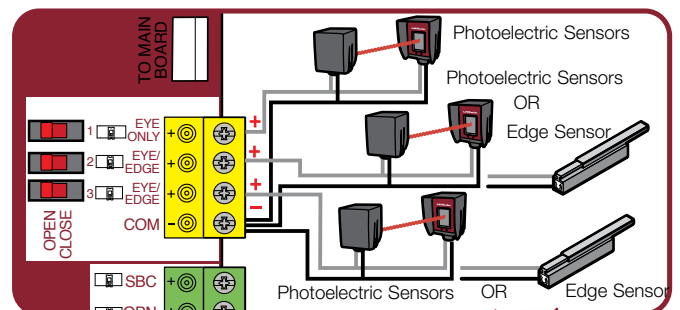

FORCE SETTING AND FINE ADJUSTMENT

SET THE FORCE

With entrapment protection attached, cycle the door open and closed using the green "TEST BUTTONS". The operator will automatically set the force.

FINE TUNE THE FORCE

The REVERSAL FORCE DIAL on the control board is used for fine tuning the force in cases where wind or environmental changes may affect the door travel.

Based on the length and weight of the door it may be necessary to make additional force adjustments. The force setting should be high enough that the door will not cause nuisance reversals, but low enough to prevent damage to door or property. The force setting is the same for both the open and close directions.

1. Open and close the door with the TEST BUTTONS.
2. If the door stops or reverses before reaching the fully open or closed position, increase the force by turning the force control slightly clockwise.
3. Perform the "Obstruction Test" after every force setting adjustment (see below).

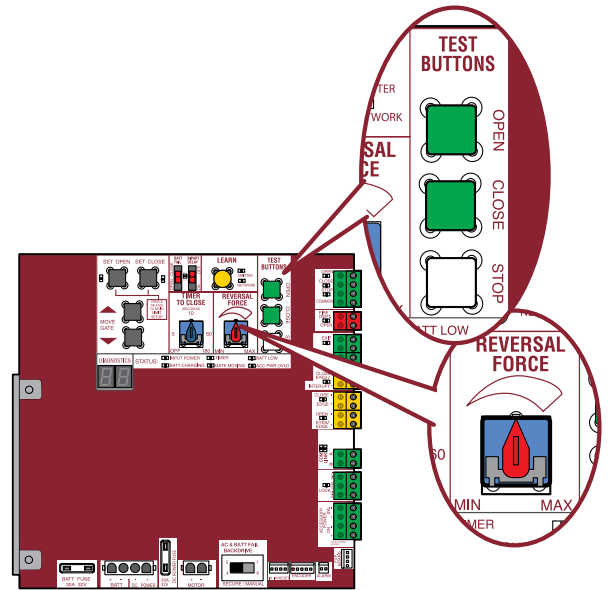

OBSTRUCTION TEST

The operator is equipped with an automatic obstruction sensing feature.

If the door encounters an obstruction during motion, the operator will automatically reverse or stop the door. After any adjustments are made, test the operator:

1. Open and close the door with the TEST BUTTONS, ensuring that the door is stopping at the proper open and close limit positions.
2. Place a solid object under the open door. Ensure that the door, and the solid object can withstand the forces generated during this obstruction test.
3. Run the door in the close direction. The door should stop and reverse upon contact with the solid object. If the door does not reverse off the solid object, reduce the force setting by turning the force control slightly counter-clockwise. The door should have enough force to reach both the open and close limits, but MUST reverse after contact with a solid object.

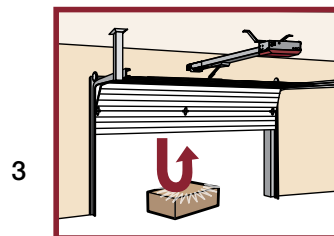
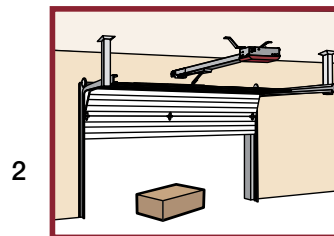
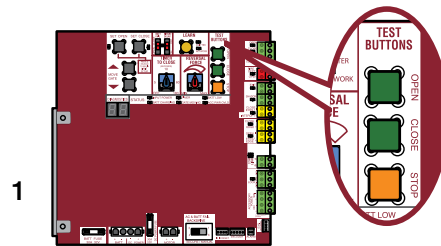

SETTING TIMER-TO-CLOSE

The TIMER-TO-CLOSE (TTC) dial can be set to automatically close the door after a specified time period.

The TTC is factory set to OFF. If the TTC is set to the OFF position, then the door will remain open until the operator receives another command from a control. Rotate the TIMER-TO-CLOSE dial to the desired setting. The range is 0 to 180 seconds, 0 seconds is OFF.

NOTE: Any radio command, single button control, or CLOSE command on the control board prior to the TTC expiring will close the door. The TTC is reset by any signals from the open controls, loops, safety edges, and close photoelectric sensors (IR's).

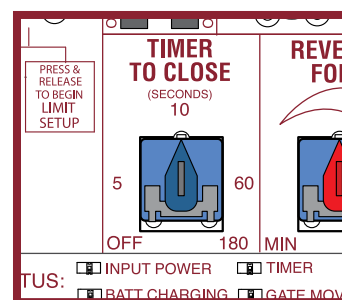

COMMISSIONING

TYPES OF SECURITY +2.0 TRANSMITTERS

All Grifco remote access devices feature Security +2.0 technology. This advanced platform cuts through interference, and ensures consistent, reliable, long range operation of your commercial door.

With inbuilt perpetual rolling code technology, Grifco Security +2.0 transmitters are safe and secure. All devices feature exceptional battery life, easy configuration and long range.

TRANSMITTER MANAGEMENT SYSTEM



The GSD-STAR1000EVO is ideal for applications requiring multiple remote access devices.

It supports up to 1,000 Security +2.0 transmitters which can be programmed through the onboard keypad and LCD screen.

Transmitters can be added or deleted singularly or in groups via an access code for added security. Transmitters can be coded offsite and backed up via an onboard memory chip. It is supplied with an antenna for exceptional range and is rated IP44 for water resistance.

GSD-STAR1000EVO is supplied with a bracket and wiring for internal mounting into the S-Drive operator.

The GSD-STAR1000EVO can be mounted internal to the S-Drive operator. See page 18 for details.

Part No.	GSD-STAR1000EVO
Description	Transmitter management for up to 1,000 Security +2.0 remote access devices



WIRELESS 4-CHANNEL KEYRING TRANSMITTER

Part No.	E960G
Description	4-channel keyring transmitter. Security +2.0 / Security+



WIRELESS 3-CHANNEL KEYRING TRANSMITTER

Part No.	E945G
Description	3-channel keyring transmitter. Security +2.0



WIRELESS VISOR TRANSMITTER

Part No.	E943G
Description	3-channel transmitter for vehicle or forklift mounting. Security +2.0



WIRELESS SECURITY KEYPAD

Part No.	E840G
Description	Wireless keypad for external keyless entry. Security +2.0

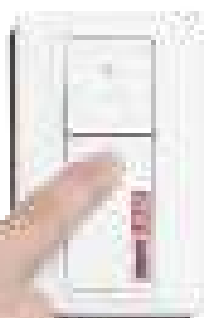

WIRELESS WALL CONTROL

Part No.	E138G
Description	2-channel transmitter for wall mounting on internal walls. Security +2.0

COMMISSIONING

COMMISSIONING REMOTE TRANSMITTERS (SOLD SEPARATELY)

A total of 50 Security+ 2.0 remote transmitters and 2 wireless keypads (1 PIN for each wireless keypad) can be programmed to the operator. When programming a third wireless keypad to the operator, the first wireless keypad will be erased to allow the third wireless keypad to be programmed.

When the operator's memory is full it will exit the programming mode and the remote transmitter will not be programmed. The memory will need to be erased before programming any additional remote transmitters.

Ensure supplied antenna is fitted to the operator prior to programming transmitters.

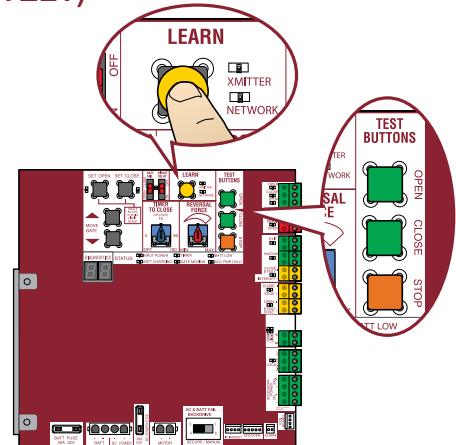

OPTION	DESCRIPTION	PROGRAM USING OPERATOR'S LEARN BUTTON
Single button as OPEN only	Program a single button on the remote transmitter for open only. The Timer-to-Close can be set to close the door.	<ol style="list-style-type: none"> 1. Press and release the LEARN button (operator will beep and green XMITTER LED will light). NOTE: The operator will time out of programming mode after 30 seconds. 2. Press the OPEN button. 3. Press the remote transmitter button that you would like to program.
Single button (SBC) as OPEN, CLOSE, and STOP (Remote transmitter behaviour will become "open only" when TTC is set)	Program one transmitter button as an open, close, and stop.	<ol style="list-style-type: none"> 1. Press and release the LEARN button (operator will beep and green XMITTER LED will light). NOTE: The operator will time out of programming mode after 30 seconds. 2. Press the remote transmitter button that you would like to program.
Three separate buttons as OPEN, CLOSE, and STOP	Program each remote transmitter button as an open, close, and stop.	<ol style="list-style-type: none"> 1. Press and release the LEARN button (operator will beep and green XMITTER LED will light). NOTE: The operator will time out of programming mode after 30 seconds. 2. Press the OPEN, CLOSE, or STOP button, depending on the desired function. 3. Press the remote transmitter button that you would like to program.

The operator will automatically exit learn mode (operator will beep and green XMITTER LED will go out) if programming is successful. To program additional Security+ 2.0 remote transmitters or transmitter buttons, repeat the programming steps above.

MOUNTING GSD-STAR1000EVO

The GSD-STAR1000EVO (sold separately) is designed to fit internally to the operator.

1. Mount the STAR1000EVO device to the mounting bracket
2. Mount the assembly (STAR1000EVO and bracket) to the internal chassis of the operator using the at the position shown right using the screws and bracket provided (ensure the antenna is mounted external to the operator)
3. Connect the cable to the Main Control Board as shown on page 18.

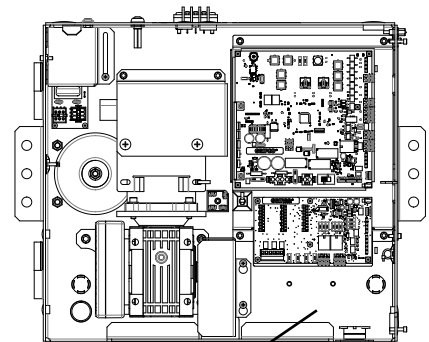

Mounting position of GSD-STAR1000EVO

ERASING TRANSMITTERS OR LIMITS

ERASE ALL CODES

1. Press and release the LEARN button (operator will beep and green XMITTER LED will light).
2. Press and hold the LEARN button again until the green XMITTER LED flashes and then release the button (approximately 6 seconds). All remote transmitter codes are now erased

ERASE LIMITS

1. To erase the limits, press and hold the SET OPEN and SET CLOSE buttons simultaneously (5 seconds) until both the SET OPEN and SET CLOSE LEDs blink rapidly and the operator beeps.
2. Release the buttons and the SET OPEN and SET CLOSE LEDs will blink slowly indicating the limits have been erased.

COMMISSIONING REMOTE TRANSMITTERS (CONT.)

LIMIT SETUP WITH A REMOTE TRANSMITTER

To set the limits using a remote transmitter, first you will need a 3-button transmitter that has been programmed for OPEN, CLOSE, and STOP. Refer to the Programming section.

INITIAL LIMITS AND FORCE ADJUSTMENT

The door **MUST** be attached to the operator before setting the limits and force.

Ensure the door is closed.

1. Press and release the SET OPEN and SET CLOSE buttons simultaneously to enter limit setting mode.
2. Press and hold the OPEN or CLOSE button on the remote transmitter until the door reaches the desired open position. The door can be jogged back and forth using the OPEN and CLOSE buttons on the remote transmitter.
3. Once the gate/door is in the desired open position, press and release the STOP button on the remote transmitter.
4. Press and release the OPEN button on the remote transmitter again to set the open limit.
5. Press and hold the CLOSE or OPEN button on the remote transmitter until the door reaches the desired close position. The door can be jogged back and forth using the OPEN and CLOSE buttons on the remote transmitter.
6. Once the door is in the desired close position, press and release the STOP button on the remote transmitter.
7. Press and release the CLOSE button on the remote transmitter again to set the close limit.
8. Cycle the door open and close. This automatically sets the force. When limits are set properly the operator will automatically exit limit setting mode.

ADJUST THE LIMITS (if needed)

If the limits have already been set the operator will exit the limit setting mode after resetting each limit.

SET THE CLOSE LIMIT ONLY

1. Press and release the SET OPEN and SET CLOSE buttons simultaneously to enter limit setting mode.
2. Press and hold the CLOSE button on the remote transmitter until the door reaches the desired close position. The Door can be jogged back and forth using the OPEN and CLOSE buttons on the transmitter.
3. Once the door is in the desired close position, press and release the STOP button on the remote transmitter.
4. Press and release the CLOSE button on the remote transmitter again to set the close limit.

When the close limit is set properly the operator will automatically exit limit setting mode.

SET THE OPEN LIMIT ONLY

1. Press and release the SET OPEN and SET CLOSE buttons simultaneously to enter limit setting mode.
2. Press and hold the OPEN button on the remote transmitter until the door reaches the desired open position. The door can be jogged back and forth using the OPEN and CLOSE buttons on the transmitter.
3. Once the gate/door is in the desired open position, press and release the STOP button on the transmitter.
4. Press and release the OPEN button on the transmitter again to set the open limit.

When the open limit is set properly the operator will automatically exit limit setting mode.

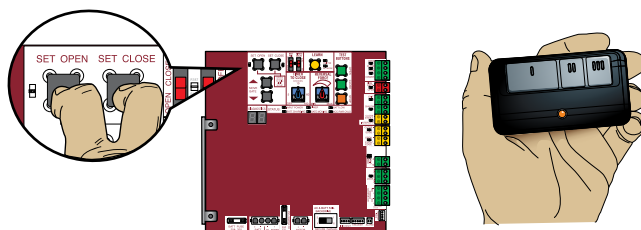

3-Button Transmitter programmed for OPEN, CLOSE and STOP

ACCESSORY WIRING

CONNECTING ACCESS CONTROL ACCESSORIES

Access control devices can either be wired internally to the operator or via the external terminal block.

INTERNAL CONNECTION

The diagram below shows where to connect access control devices such as card readers, keypads or key switches etc.

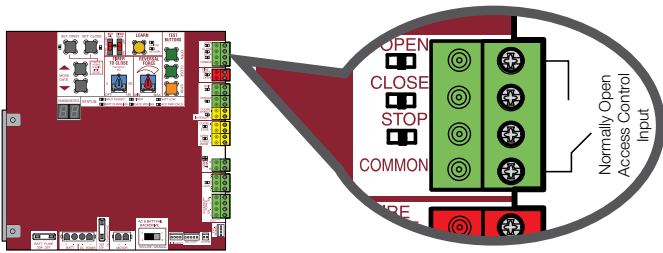

EXTERNAL CONNECTION

External terminals are provided for installations where 3rd party devices can be connected without the need to gain entry to the operator enclosure. Terminals are located on the rear of the operator, near the Reset Button.

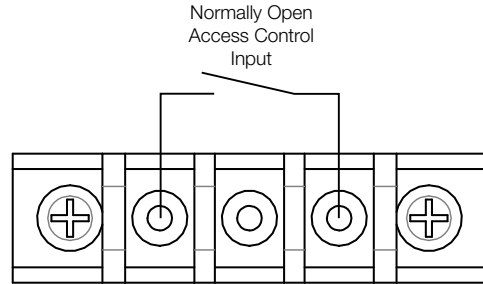

CONNECTING EXTERNAL CONTROL DEVICES

EXIT (2 Terminals)

This input is a soft open command (maintained switch does not override external safeties and does not reset alarm condition). Used for exit probe, telephone entry, external exit loop detector, or any device that would command the door to open.

- Opens a closing door and holds open an open door, if maintained, pauses Timer-to-Close at OPEN limit.

SHADOW (2 Terminals)

This input is used for external shadow loop detector when loop is positioned under the swing of the door.

- Holds open door at open limit
- Only active when the door is at the OPEN limit, disregarded at all other times
- Pauses Timer-to-Close at OPEN limit

INTERRUPT (2 Terminals)

This input is used for photoelectric sensors and external interrupt loop detector when loop is on the outside of the door.

- Holds open door at open limit
- Stops and reverses a closing door to open limit
- Pauses Timer-to-Close at OPEN limit, activates quick close and anti-tailgate features when enabled on the expansion board

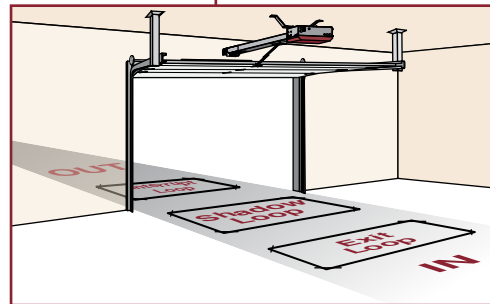
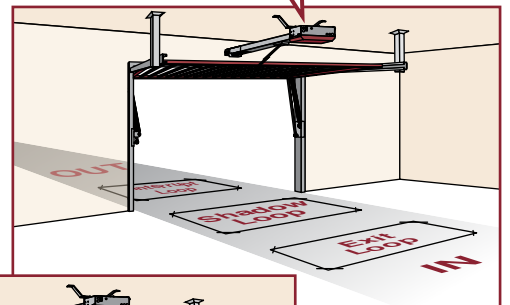
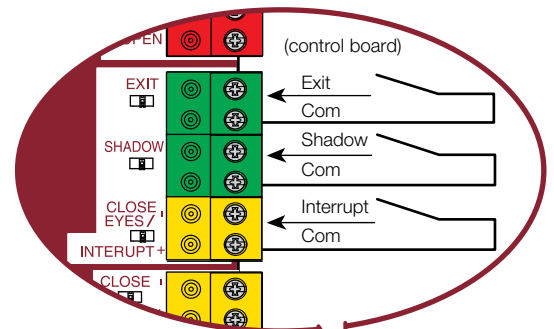

ACCESSORY WIRING

MISCELLANEOUS WIRING

THREE BUTTON CONTROL STATION (4 Terminals)

- **OPEN and COM:** Opens a closed door.
Hard open (maintained switch overrides external safeties and resets alarm condition). If maintained, pauses Timer-to-Close at OPEN limit. Opens a closing door and holds open an open door (within line-of-sight).
- **CLOSE and COM:** Closes an open door.
Hard close (maintained switch overrides external safeties and resets alarm condition within line-of-sight)
- **STOP and COM:** Stops a moving door.
Hard stop (maintained switch overrides Open and Close commands and resets alarm condition). Cancels/resets Timer-to-Close at OPEN limit. Overrides Open and Close commands (within line-of-sight).

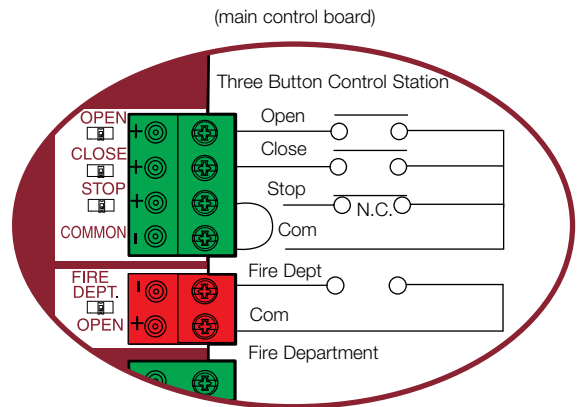

FIRE DEPARTMENT OPEN INPUT (2 Terminals)

Acts as hard open.

Hard open (maintained switch overrides external safeties and resets alarm condition). If maintained, pauses Timer-to-Close at OPEN limit.

Opens a closing door and holds open an open door (within line-of-sight). Bypasses any prewarning delay.

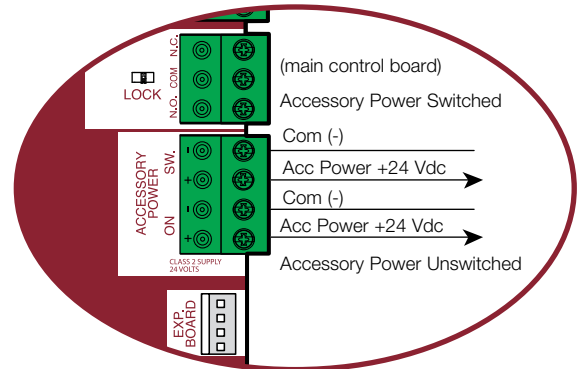

ACCESSORY POWER 24 VDC, MAX 500 MA (4 Terminals)

- **SWITCHED:** Switched ON when the door is in motion. Turns off after a 5 second delay when the door stops. The power will remain ON at the open limit when Timer-to-Close is enabled and when the Timer-to-Close is counting down.
- **UNSWITCHED:** 24 Vdc voltage out to power accessories, always ON.

OPERATION

RESET BUTTON

The reset button is located on the back of the operator and serves several functions:

- Press the reset button to stop a moving door during a normal open/close cycle, like a stop button.
- Press the reset button once while the door is in open position to disable the Timer-to-Close. The door will stay in the open position. To restart the Timer-to-Close either press the reset button or activate the door with a programmed remote transmitter.
- Press the reset button to shut off the alarm and reset the operator.

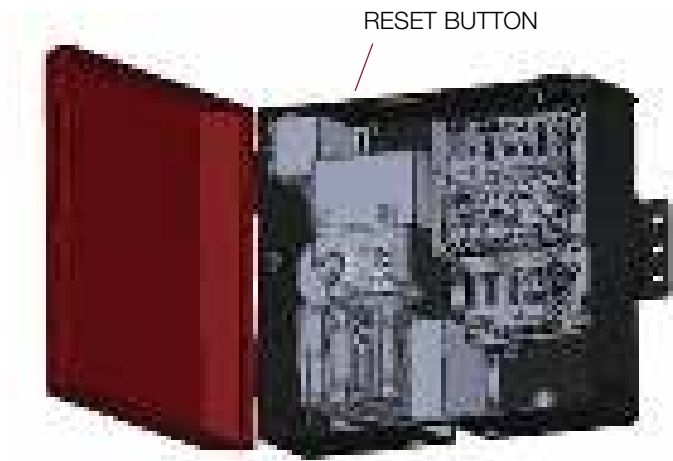

OPERATION

OPERATOR ALARM

The operator alarm will beep 3 times with a command if the battery is low.

When the inherent force of the operator (RPM/current sensor) detects the following (twice consecutively) the alarm will sound (up to 5 minutes) and the operator will need to be reset:

- A. The door hits an obstruction
- B. The door has a broken wheel(s) or damaged track
- C. The door has broken springs or hardware
- D. Trolley is hitting the chassis or an unwanted object

Remove any obstructions. Press the reset button to shut off the alarm and reset the operator. After the operator is reset, normal functions will resume.

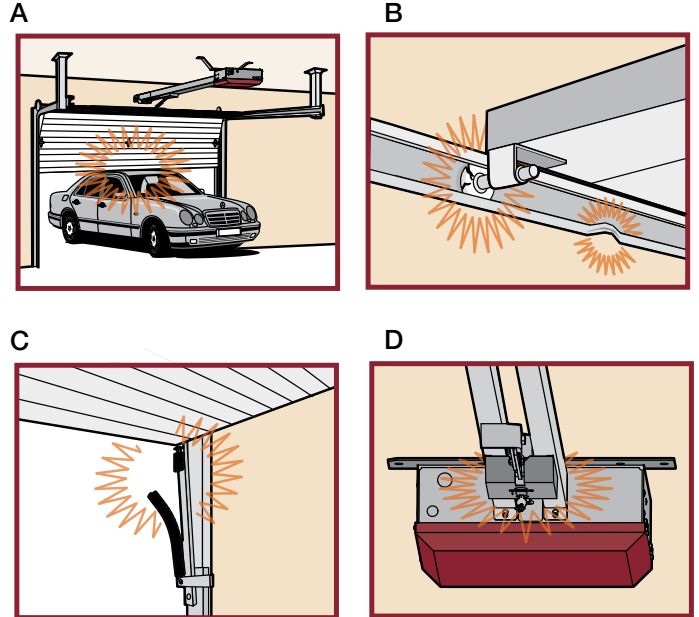

MANUAL DISCONNECT

STEP 1

Hold the J-bar with one arm and pull the release rope with the other arm.

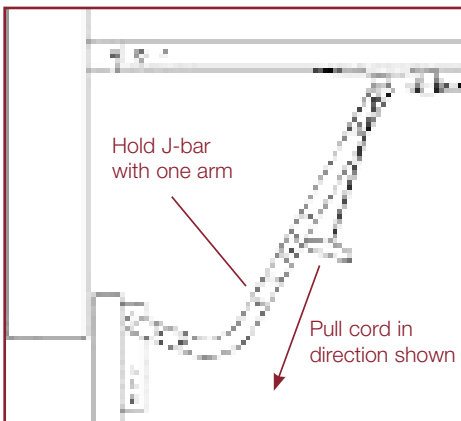

STEP 2

Lift the door up until fully open

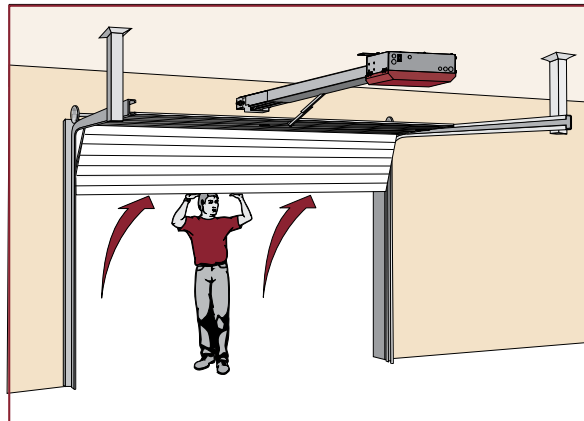

To re-connect, re-attach the push arm by pulling the emergency release rope and connecting to the trolley pin.



WARNING

Activation of manual release may cause uncontrolled movement of the door due to mechanical failure or out-of-balance conditions.

EXPANSION BOARD

AUXILIARY RELAYS

AUX RELAY 1 AND 2

Normally Open (N.O.) and Normally Closed (N.C.) relay contacts to control external devices, for connection low voltage (42 Vdc [34 Vac] max 5 Amps) power sources only.

AUX RELAY SETTING	SWITCH SETTINGS			AUX RELAY 1	AUX RELAY 2
	1	2	3		
Off (no feature selected)	OFF	OFF	OFF	Relay always off. Use this Aux Relay setting to conserve battery power.	
Open Limit Switch	OFF	OFF	ON	Energizes at open limit.	
Close Limit Switch	OFF	ON	OFF	Energizes when not at close limit. For an additional audible or visual display, connect an external light (low voltage).	
Door Motion	OFF	ON	ON	Energizes when motor is on (door in motion). For an additional audible or visual display, connect an external buzzer or light (low voltage).	
Pre-Motion Delay	ON	OFF	OFF	Energizes 3 seconds before door motion and remains energized during door motion. The on board alarm will sound. For an additional audible or Visual display, connect an external buzzer or light (low voltage).	Energizes 3 seconds before door motion and remains energized during door motion. For an additional audible or visual display, connect an external buzzer or light (low voltage).
Power	ON	ON	OFF	Energizes when AC power or solar power is present. There is approximately a 10-12 second delay before relay cutoff, after AC shutdown.	Energizes when on battery power. There is approximately a 10-12 second delay before relay cutoff, after AC shutdown.
Tamper	ON	OFF	ON	Energizes if gate/door is manually tampered with by being pushed off of close limit. For an additional audible or visual display, connect an external buzzer or light (low voltage).	Energizes if gate/door is manually tampered with by being pushed off of close limit. For an additional audible or visual display, connect an external buzzer or light (low voltage).
Cycle Quantity Feedback*	ON	ON	ON	The 1, 2, and 3 LEDs will blink out the cycle count (cycle count is stored on the control board). See below.	Red/green light functionality. See BELOW.

CYCLE COUNT

To determine the actual cycles that the door operator has run (in thousands), set all three Aux Relay switches to the ON setting for Aux Relay 1. The Expansion Board's 1, 2, and 3 LEDs will blink out the cycle count.

- 1 LED blinking 1000's
- 2 LED blinking 10,000's
- 3 LED blinking 100,000's
- Simultaneously all three LED's blink 1,000,000's

For example, 1 LED blinks 3 times, 2 LED blinks 6 times, and 3 LED blinks once. Cycle count is 163,000.

Cycle count displayed is between 1,000 and 9,999,000 cycles. After servicing, set Aux Relay switches back to their appropriate positions. Cycle count cannot be reset or changed. If under 1,000 cycles the 1, 2, and 3 LEDs will turn on for 10 seconds, then turn off.

NOTE: The expansion board will flash the cycle count 3 times then all the LEDs will turn on solid for 10 seconds then turn off.

AUX RELAY 1 AND 2 WIRING DETAILS

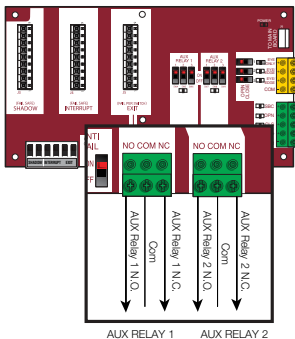

Switch Settings				
1	2	3	RELAY 1	RELAY 2
OFF	OFF	OFF	Relay always off	Relay always on
OFF	OFF	ON	Energizes at open limit	Energizes at open limit
OFF	ON	OFF	Energizes when not at close limit	Energizes when not at close limit
OFF	ON	ON	Energizes when motor is on	Energizes when motor is on
ON	OFF	OFF	Energizes and alarms 3 seconds prior and during door automation	Energizes 3 seconds prior and during door automation
ON	ON	ON	Energizes when door is tampered with	Energizes when door is tampered with
ON	OFF	ON	LEDs will blink cycle count	Red / Green light functionality
ON	ON	ON		

/ Green Light Functionality					
light wired to AUX RELAY 1					
Green Light wired to AUX RELAY 2					
Door State	AUX RELAY 1 SWITCHES			AUX RELAY 2 SWITCHES	
	1 OFF	2 OFF	3 OFF	1 ON	2 ON
CLOSED				Green light OFF	
OPENING				Green light OFF	
OPEN				Green light ON	
CLOSING				Green light OFF	
Defined mid stop				N/A	
Undefined mid stop				Green light OFF	
Timer more than 5 seconds				Green light ON	
Timer less than 5 seconds				Green light OFF	

* For when door is closed, set switch on AUX RELAY 1 to ON

AUXILIARY RELAY WIRING EXAMPLE

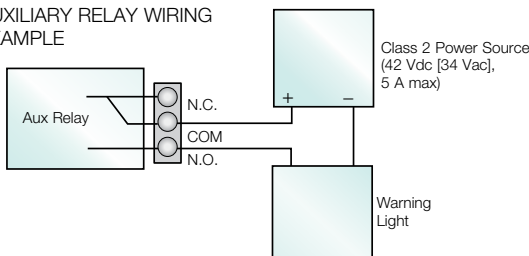

EXPANSION BOARD

WIRING ACCESSORIES TO THE EXPANSION BOARD

Refer to the chart below and the corresponding image for a description of the expansion board inputs.

A	Entrapment Protection Device Inputs (4 terminals total), Open or Close Direction based on switch setting next to inputs	<p>EYES ONLY Input: Open or Close Direction Photoelectric Sensors, Close: reverses fully, Open: stops door</p> <p>EYES/EDGE Input(s): Open or Close Direction Photoelectric Sensors, Infra-red detector wired or Edge Sensor, Close: reverses fully, Open: stops door</p>
B	Single Button Control, SBC (2 terminals)	Door command sequence - Open, Stop, Close, Stop, ... Soft Open ,Soft Close, Soft Stop (maintained switch does not override external safeties and does not reset alarm condition)
C	Open Input (& common) (3-Button Control Station, 4 terminals total)	Open command - opens a closed door. Soft open (maintained switch does not override external safeties and does not reset alarm condition) If maintained, pauses Timer-to-Close at OPEN limit. Opens a closing door and holds open an open door.
D	Close Input (& common) (3-Button Control Station, 4 terminals total)	Close command - closes an open door. Soft close (maintained switch does not override external safeties and does not reset alarm condition)
E	Stop Input (& common) (3-PB station, 4 terminals total)	Stop command - stops a moving door. Hard stop (maintained switch overrides Open and Close commands and resets alarm condition) If maintained, pauses Timer-to-Close at OPEN limit. Overrides an Open or Close command.
F	Exit Loop Input (2 terminals)	Loop wire connection for plug-in loop detector when loop is inside secured area near door. Open command - opens a closed door. Soft open (maintained switch does not override external safeties and does not reset alarm condition) If maintained, pauses Timer-to-Close at OPEN limit. Opens a closing door and holds open an open door.
G	Shadow Loop Input (2 terminals)	Loop wire connection for plug-in loop detector when loop is positioned under the door. - Holds open door at open limit - Disregarded during door motion - Pauses Timer-to-Close at Open Limit
H	Interrupt Loop Input (2 terminals)	Loop wire connection for plug-in loop detector when loop is along the side of the door. - Holds open door at open limit - Stops and reverses a closing door - Pauses Timer-to-Close at Open Limit - Activates quick close and anti-tail features if enabled

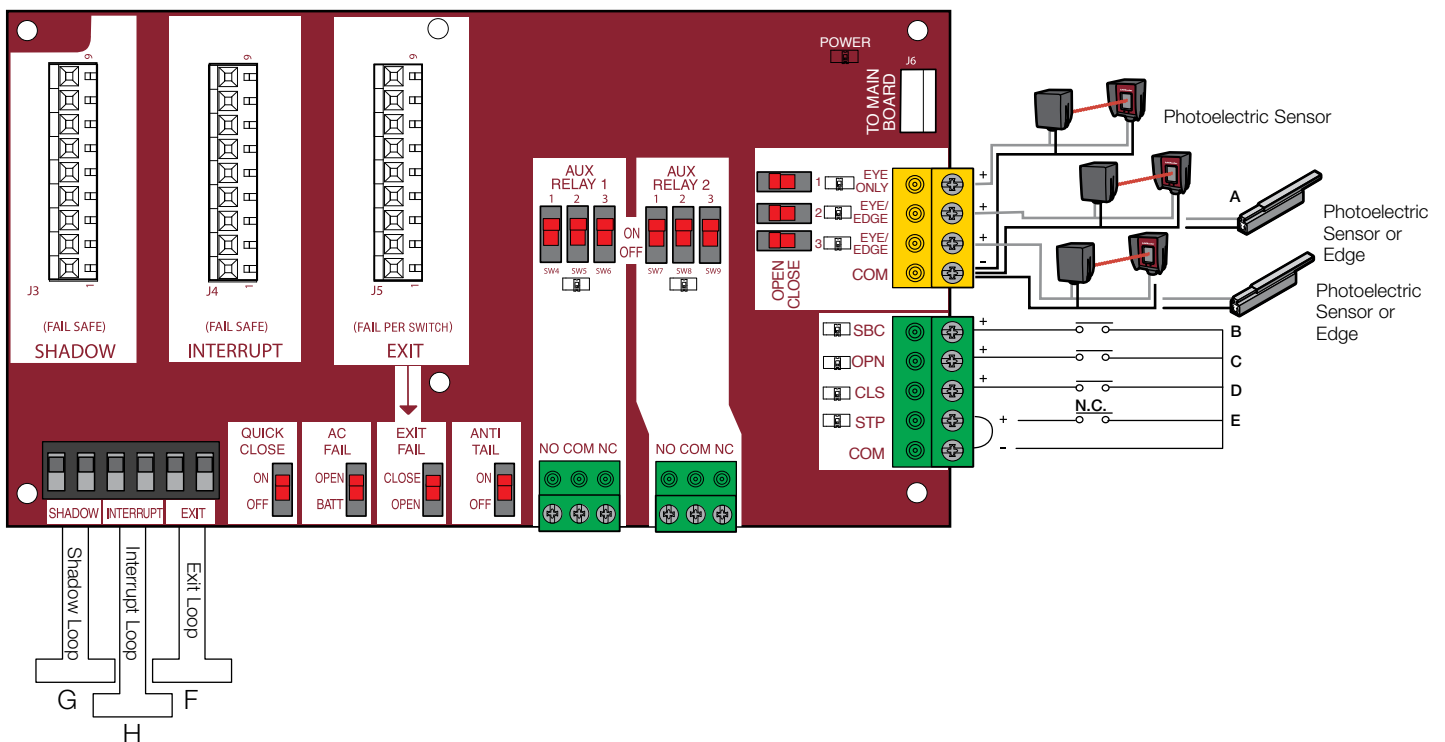

MAINTENANCE

MAINTENANCE CHART

Disconnect all power (AC, battery) to the operator before servicing. The operator's AC Power switch ONLY turns off AC power to the control board and DOES NOT turn off battery power. ALWAYS disconnect the batteries via the J15 plug to service the operator (refer page 10).

DESCRIPTION	TASK	CHECK AT LEAST ONCE EVERY		
		MONTH	6 MONTHS	3 YEARS
Entrapment Protection Devices	Check and test for proper operation	X		
Manual Disconnect	Check and test for proper operation		X	
Door	Make sure the door operates smoothly without the operator	X		
Door Track	Make sure the door track runs smoothly	X		
Accessories	Check all for proper operation		X	
Operator Rail	Inspect and maintain the rail to ensure there is no corrosion		X	
Electrical	Inspect all wire connections and circuit boards for visible wear or damage		X	
Operator	Inspect for wear or damage		X	
Chain	Check tension and lubricate if needed		X	
Batteries	Inspect the batteries and test the operator works without mains connected		Test	Replace

In coastal applications, extra care is required to prevent corrosion on rail and other metal components.

BATTERY MAINTENANCE

Batteries will degrade over time depending on temperature and usage. The operator alarm will beep 3 times with a command if the battery is low. Batteries do not perform well in extremely cold temperatures. For best performance, the batteries should be replaced every 3 years. Use only Grifco replacement batteries. The operator comes with two 7AH batteries. The batteries contain lead and need to be disposed of properly. If batteries are leaking, safely remove them and dispose of them properly. See page 9 for instructions.



WARNING

To reduce the risk of SEVERE INJURY or DEATH: READ AND FOLLOW ALL INSTRUCTIONS.

- ALL maintenance MUST be performed by a Grifco professional.
- ANY maintenance to the operator or in the area near the operator MUST NOT be performed until disconnecting the electrical power

(AC or solar and battery) and locking-out the power via the operator power switch. Upon completion of maintenance the area MUST be cleared and secured, at that time the operator may be returned to service.

- NEVER let children operate or play with door controls. Keep the transmitter away from children.
- ALWAYS keep people and objects away from the door. NO ONE SHOULD CROSS THE PATH OF THE MOVING DOOR.
- The entrance is for vehicles ONLY. Pedestrians MUST use separate entrance.

- Test the door operator monthly. The door MUST reverse on contact with a rigid object or reverse when an object activates the non-contact sensors. After adjusting the force or the limit of travel, retest the door operator. Failure to adjust and retest the door operator properly can increase the risk of INJURY or DEATH.
- Use the manual disconnect release ONLY when the gate/door is not moving.
- KEEP DOOR PROPERLY MAINTAINED. Read the owner's manual. Have a qualified service person make repairs to door hardware.
- Activate gate/door ONLY when it can be seen clearly, is properly adjusted and there are no obstructions to gate/door travel.
- To reduce the risk of FIRE or INJURY to persons use ONLY Grifco replacement batteries.
- Dispose of used batteries properly
- SAVE THESE INSTRUCTIONS.



WARNING

Always wear protective gloves and eye protection when changing the battery or working around the battery compartment.

TROUBLESHOOTING

VIEWING DIAGNOSTIC CODES

TO VIEW THE CODES:

The codes will show on the Diagnostic Display

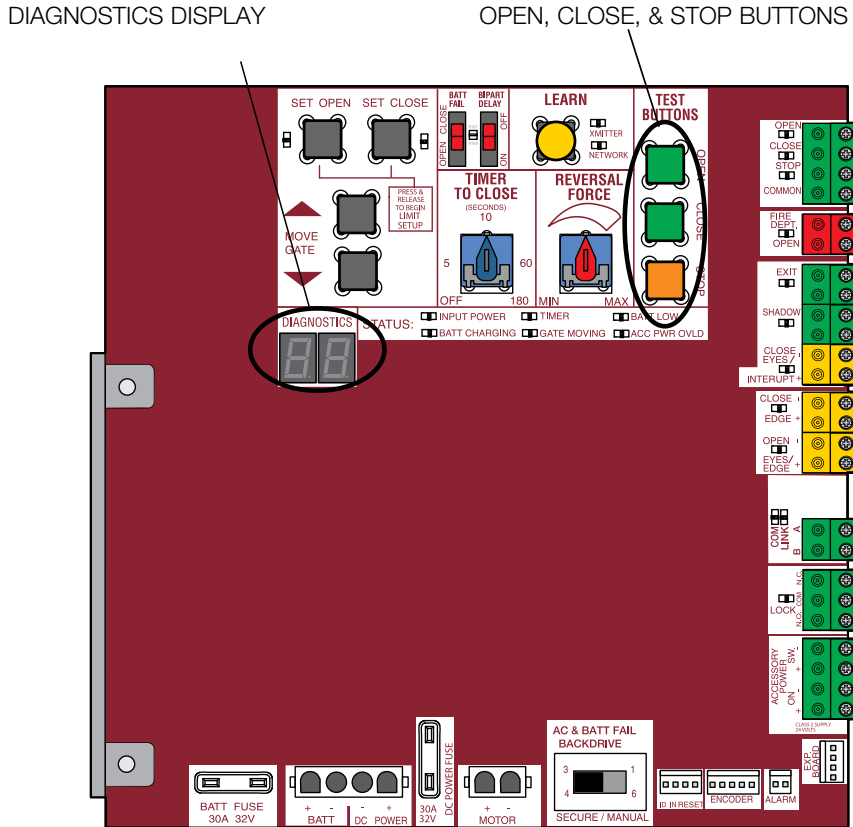

Press and hold the STOP button

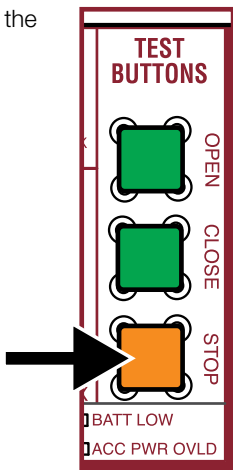

... then press and hold the CLOSE button

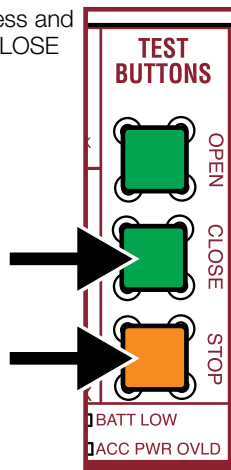

... then press and hold the OPEN button until "ER" shows on the display

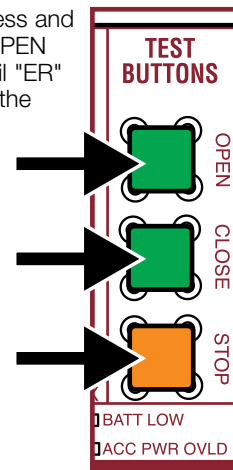

WARNING

To protect against fire and electrocution:

- DISCONNECT power (AC or solar and battery) BEFORE installing or servicing operator.

For continued protection against fire:

- Replace ONLY with fuse of same type and rating.

VIEWING DIAGNOSTIC CODES (CONT.)

The operator will show the code sequence number followed by the code number:

CODE SEQUENCE NUMBER

The first number shown is the most recent code (example: "01").

The display will show the sequence of codes that occurred starting with "01" and going up to code "20".

... A SECOND LATER ...

CODE NUMBER

The second number shown after the code sequence number is the code itself (31-99, example "31"). Refer to the chart on the following page for an explanation of each code.

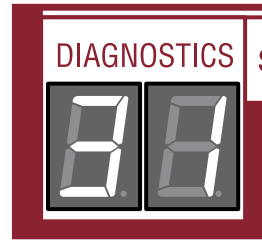
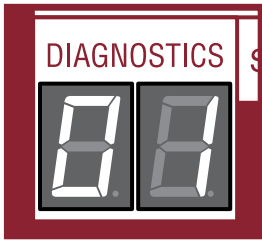

TO SCROLL THROUGH SAVED CODES:

Press the OPEN Button to cycle to the most recent code ("01")

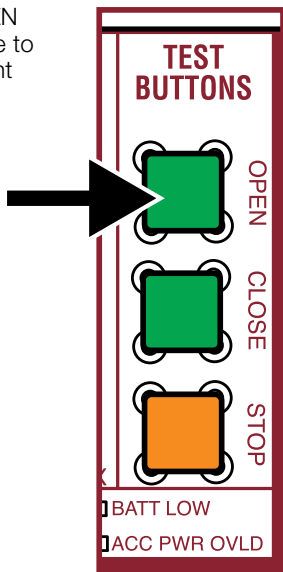

Press the Close Button to cycle to the oldest code (up to "20")

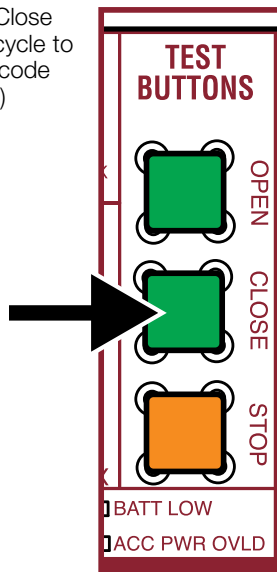

TO EXIT:

Press and release the STOP Button to exit. The display will also time out after two minutes of inactivity

TO RESET THE CODE HISTORY:

1. Press and hold the STOP button for six seconds. The display will show "Er" then "CL" alternately for six seconds.
2. Release the STOP button. The code history has now been reset and the display will show "- -" until a new code occurs.
3. Press and release the STOP button to exit.

TROUBLESHOOTING

DIAGNOSTIC CODES CHART

Some codes are saved in the code history and some are not. If a code is not saved it will briefly appear on the display as it occurs, then disappear.

Grifco System
 Installed System
 Informational
 External Entrapment Protection (Safety Input Event)
 Inherent Entrapment Protection (Force Based Event)

Code	Meaning	Solution	Saved
31	Main control board has experienced an internal failure.	Disconnect all power, wait 15 seconds, then reconnect power (reboot). If issue continues, replace main control board	NO
34	Absolute Position Encoder Error, not getting position information from encoder	Check APE assembly and wiring connections. Replace the APE assembly if necessary	YES
35	Max-Run-Time Exceeded Error / Motor Overload	Motor overload detected. Check door for obstruction, binding or a broken spring. Once the operator cools, normal operation will resume.	YES
36	Product ID Error	Was the control board just replaced? If so, erase limits, enter limit setup mode and set limits. If not, disconnect all power, wait 15 seconds, then reconnect power before changing product ID harness	YES
37	Product ID Failure	Unplug product ID harness then plug back in. Disconnect all power, wait 15 seconds, then reconnect power before replacing product ID harness.	YES
38	Hard Stop Limit	Limit may be set too tightly against a non-resilient hard stop (re-adjust limit). Operator may be at end of travel (re-adjust mounting)	NO
40	Battery overvoltage	Too much voltage on the battery. Check harness. Make sure there is NOT a 24V battery on a 12V system	YES
41	Battery overcurrent	Possible short of the battery charge harness. Check harness. Make sure you do NOT have a 12V battery on a 24V system	YES
42	No battery at boot up	Check battery connections and installation. Replace batteries if depleted to less than 20V on a 24V system or less than 10V on a 12V system. Make sure there is NOT a single 12V battery on a 24V system	YES
43	Exit Loop Error	Failure or missing loop. Check loop wiring throughout connection. May be a short in the loop, or an open connection in the loop	YES
44	Shadow Loop Error		
45	Interrupt Loop Error		
46	Wireless edge battery low	Replace batteries in wireless edge	YES
50	Run-Distance Error	Door out of balance detected. Check counterbalance spring condition and setting	YES
53	Brownout occurred	AC/DC board supply dipped below allowable level. Review power supply and wiring. If rebooting, ensure enough time for discharge of power to force a fresh boot	YES

TROUBLESHOOTING

DIAGNOSTIC CODES CHART (CONT.)

Some codes are saved in the code history and some are not. If a code is not saved it will briefly appear on the display as it occurs, then disappear.

Grifco System
 Installed System
 Informational
 External Entrapment Protection (Safety Input Event)
 Inherent Entrapment Protection (Force Based Event)

Code	Meaning	Solution	Saved
60	Minimum number of monitored entrapment protection devices (one) not installed	Review monitored entrapment protection device connections	NO
61	CLOSE EYE/INTERRUPT held more than 3 minutes	Check wired input on main control board; check for alignment or obstruction	YES
62	CLOSE EDGE held more than 3 minutes		
63	OPEN EYE/EDGE held more than 3 minutes		
64	CLOSE EYE/INTERRUPT held more than 3 minutes	Check wired input on expansion board; check for alignment or obstruction	YES
65	CLOSE EYE/EDGE held more than 3 minutes		
66	OPEN EYE/EDGE held more than 3 minutes		
67	Wireless edge triggered more than 3 minutes	Check wired input for wiring issue or obstruction	YES
68	Wireless edge loss of monitoring	Check wireless edge inputs	YES
69	Wireless edge triggered	IF an obstruction occurred, no action required. If an obstruction did NOT occur, check inputs and wiring.	NO
70	CLOSE EYE/INTERRUPT triggered, causing reversal, preventing close, or resetting TTC	IF an obstruction occurred, no action required. If an obstruction did NOT occur, check alignment, inputs, and wiring on main control board	NO
71	CLOSE EDGE triggered, causing reversal, preventing close, or canceling TTC		
72	OPEN EYE/EDGE triggered, causing reversal or preventing opening		
73	CLOSE EYE/INTERRUPT triggered, causing reversal, preventing close, or resetting TTC	IF an obstruction occurred, no action required. If an obstruction did NOT occur, check alignment, inputs, and wiring on expansion board	NO
74	CLOSE EYE/EDGE triggered, causing reversal and preventing close or canceling TTC		
75	OPEN EYE/EDGE triggered, causing reversal or preventing opening		
80	Close input (EYE/EDGE) communication fault from other operator	Check inputs and communication method between operators, either wired bus or radio. Ensure operator is powered. May have to erase the wireless communication and reprogram the two operators	YES
81	Open input (EYE/EDGE) communication fault from other operator		
82	Close input (EYE/EDGE) communication fault (expansion board)		
83	Open input (EYE/EDGE) communication fault (expansion board)	Check the connections between the main board and the expansion board	YES
91	Force Reversal (Operator 1)	Check for obstruction. If no obstruction, check that the mechanical assembly is engaged and free to move. See section on Limit and Force Adjustment, and Obstruction Test	YES
93	RPM / STALL Reversal (Operator 1)	Check for obstruction. If no obstruction, check the operator wiring and that the mechanical assembly is engaged and free to move. Replace APE assembly	YES
99	Normal Operation	No action required	YES

TROUBLESHOOTING

OPERATOR ALARM CHART

ALARM CHART	
1 beep every 3 seconds during door operation	Operator is operating from battery power. AC power not connected
3 beeps every 3 seconds during door operation	Operator is operating from LOW battery power. AC power not connected.
2 beeps every minute (constant)	Operator has encountered a double force based obstruction.

CONTROL BOARD LEDS

STATUS LEDS		
INPUT POWER	OFF	OFF state
	ON	AC charger or Solar power available
BATT CHARGING	OFF	Not charging
	ON	Three stage battery charging
TIMER	OFF	The timer is disabled
	ON	The timer is enabled
	MEDIUM BLINK (1 blink per second)	The timer is running
	FAST BLINK (2 blinks per second)	The timer is paused
DOOR MOVING	OFF	The door is stopped
	ON	The door is opening or closing
	MEDIUM BLINK (1 blink per second)	One force event
	FASTEST BLINK (8 blinks per second)	Two force events
BATT LOW	OFF	No battery error
	ON	Battery low
	BLINK (1 blink per second)	Battery critically low
ACC PWR OVLD	OFF	OFF state
	ON	Accessory overload protector opened

INPUT LEDS		
OPEN, CLOSE, & STOP INPUT	OFF	Input inactive
	ON	Input active
	BLINK	Input active on other operator
FIRE DEPT INPUT	OFF	Input inactive
	ON	Input active
	BLINK	Input active on other operator
EXIT	OFF	Input inactive
	ON	Input active
	BLINK	Input active on other operator
SHADOW	OFF	Input inactive
	ON	Input active
	BLINK	Input active on other operator
CLOSE EYES/ INTERRUPT	OFF	Input inactive
	ON	Input active
	BLINK	Input active on other operator
CLOSE EDGE	OFF	Input inactive
	ON	Input active
	BLINK	Input active on other operator
OPEN EYES/EDGE	OFF	Input inactive
	ON	Input active
	BLINK	Input active on other operator
LOCK	OFF	Maglock relay inactive
	ON	Maglock relay active

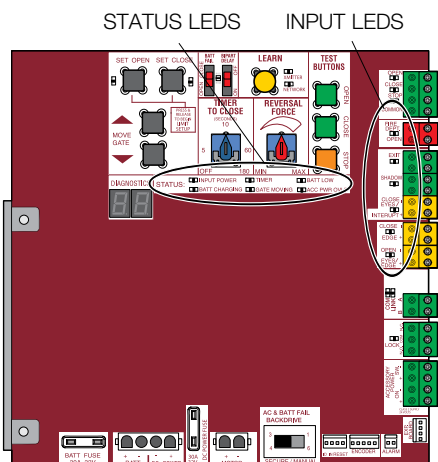

TROUBLESHOOTING

TROUBLESHOOTING CHART

SYMPTOM	POSSIBLE CAUSES	SOLUTIONS
Operator does not run and diagnostic code display not on	<ul style="list-style-type: none"> a) No power to control board b) Open fuse c) If on battery power only, low or dead batteries d) Defective control board 	<ul style="list-style-type: none"> a) Check AC and battery power. b) Check fuses. c) Charge batteries or replace batteries. d) Replace defective control board.
Control board powers up, but motor does not run	<ul style="list-style-type: none"> a) Reset switch is stuck b) Stop button active or jumper not in place for stop circuit c) If on battery power only, low or dead batteries d) Open or Close input active e) Entrapment Protection Device active f) Vehicle loop detector or probe active g) Defective control board 	<ul style="list-style-type: none"> a) Check reset switch. b) Check Stop button is not “stuck on”, or verify that the stop button is a normally closed circuit, or put a jumper on the stop circuit. c) Charges batteries or replace batteries. d) Check all Open and Close inputs for a “stuck on” input . e) Check all Entrapment Protection Device inputs for a “stuck on” sensor. f) Check all vehicle detector inputs for a “stuck on” detector. g) Replace defective control board.
Door moves, but cannot set correct limits	<ul style="list-style-type: none"> a) Door does not move to a limit position b) Door is too difficult to move c) Limits are set too close 	<ul style="list-style-type: none"> a) Use manual disconnect, manually move door, and ensure door moves easily limit to limit. Repair door as needed. b) Door must move easily and freely through its entire range, limit to limit. Repair door as needed. c) Ensure the door moves at least one foot (30.5 cm) between the OPEN limit and the CLOSE limit.
Door does not fully open or fully close when setting limits	<ul style="list-style-type: none"> a) Door does not move to a limit position b) Door is too difficult to move 	<ul style="list-style-type: none"> a) Use manual disconnect, manually move door, and ensure door moves easily limit to limit. Repair door as needed. b) Door must move easily and freely through its entire range, limit to limit. Repair door as needed.
Operator does not respond to a wired control/ command (example: Open, Close, SBC, etc.)	<ul style="list-style-type: none"> a) Check Open and Close command input LEDs b) Stop button is active c) Reset button is stuck d) If on battery power only, low or dead batteries e) Entrapment Protection Device active f) Vehicle loop detector or vehicle probe active 	<ul style="list-style-type: none"> a) Check all Open and Close inputs for a “stuck on” input. b) Check Stop button is not “stuck on”. c) Check Reset button. d) Charges batteries or replace batteries. e) Check all Entrapment Protection Device inputs for a “stuck on” sensor. f) Check all vehicle detector inputs for a “stuck on” detector.
Operator does not respond to a wireless control or remote transmitter	<ul style="list-style-type: none"> a) Check XMITTER LED when wireless control is active b) Stop button is active c) Reset button is stuck d) Poor radio reception 	<ul style="list-style-type: none"> a) Activate wireless control and check XMITTER LED is on. Re-learn wireless control/remote transmitter to control board. Replace wireless control as needed. b) Check Stop button is not “stuck on”. c) Check Reset button. d) Check if similar wired control operates correctly. Check if wireless controls works properly when within a few feet of operator. Check operator’s antenna and antenna wire. Check other wireless controls or devices.
Door stops during travel and reverses immediately	<ul style="list-style-type: none"> a) Control (Open, Close) becoming active b) Vehicle loop detector active c) Low battery voltage 	<ul style="list-style-type: none"> a) Check all Open and Close inputs for an active input. b) Check all vehicle detector inputs for an active detector. c) Battery voltage must be 23.0 Vdc or higher. Charge batteries or replace batteries.
Door opens, but will not close with remote or Timer-to-Close	<ul style="list-style-type: none"> a) Open control active b) Vehicle loop detector active c) Loss of AC power with AC FAIL set to OPEN d) Low battery with LOW BATT set to OPEN e) Fire Dept input active f) Timer-to-Close not set g) Close Entrapment Protection Device active 	<ul style="list-style-type: none"> a) Check all Open inputs for an active input. b) Check all vehicle detector inputs for an active detector. c) Check AC power and AC Fail option setting. d) Check if AC power is available. If no AC power, then running on batteries and battery voltage must be 23.0 Vdc or higher. Charge batteries or replace batteries. e) Check Fire Dept input. f) Check Timer-to-Close (TTC) setting. g) Check all Entrapment Protection Device inputs for an active sensor.
Door closes, but will not open	<ul style="list-style-type: none"> a) Vehicle loop detector active b) Low battery with LOW BATT option set to CLOSE 	<ul style="list-style-type: none"> a) Check all vehicle detector inputs for an active detector. b) Check if AC power is available. If no AC power, then running on batteries and battery voltage must be 23.0 Vdc or higher. Charge batteries or replace batteries.

TROUBLESHOOTING

TROUBLESHOOTING CHART continued...

SYMPTOM	POSSIBLE CAUSES	SOLUTIONS
Exit loop activation does not cause door to open	<ul style="list-style-type: none"> a) Exit vehicle detector setup incorrectly b) Defective Exit loop detector c) Low battery with LOW BATT option set to CLOSE 	<ul style="list-style-type: none"> a) Review Exit loop detector settings. Adjust settings as needed. b) Replace defective Exit loop detector c) Check if AC power is available. If no AC power, then running on batteries and battery voltage must be 23.0 Vdc or higher. Charge batteries or replace batteries
Interrupt loop does not cause door to stop and reverse	<ul style="list-style-type: none"> a) Vehicle detector setup incorrectly b) Defective vehicle loop detector c) Anti-tail set to ON 	<ul style="list-style-type: none"> a) Review Interrupt loop detector settings. Adjust settings as needed. b) Replace defective Interrupt loop detector. c) Set anti-tail to OFF
Shadow loop does not keep door at open limit	<ul style="list-style-type: none"> a) Vehicle detector setup incorrectly b) Defective vehicle loop detector 	<ul style="list-style-type: none"> a) Review Shadow loop detector settings. Adjust settings as needed. b) Replace defective Shadow loop detector
Obstruction in door's path does not cause door to stop and reverse	<ul style="list-style-type: none"> a) Force adjustment needed 	<ul style="list-style-type: none"> a) Refer to the Adjustment section to conduct the obstruction test and perform the proper force adjustment that is needed
Photoelectric sensor does not stop or reverse door	<ul style="list-style-type: none"> a) Incorrect photoelectric sensor wiring b) Defective photoelectric sensor 	<ul style="list-style-type: none"> a) Check photoelectric sensor wiring. Retest that obstructing photoelectric sensor causes moving door to stop, and may reverse direction b) Replace defective photoelectric sensor. Retest that obstructing photoelectric sensor causes moving door to stop, and may reverse direction
Edge Sensor does not stop or reverse door	<ul style="list-style-type: none"> a) Incorrect edge sensor wiring b) Defective edge sensor 	<ul style="list-style-type: none"> a) Check edge sensor wiring. Retest that activating edge sensor causes moving door to stop and reverse direction b) Replace defective edge sensor. Retest that activating edge sensor causes moving door to stop and reverse direction
Alarm sounds for 5 minutes or alarm sounds with a command	<ul style="list-style-type: none"> a) Double entrapment occurred (two obstructions within a single activation) 	<ul style="list-style-type: none"> a) Check for cause of entrapment (obstruction) detection and correct. Press the reset button to shut off alarm and reset the operator
Alarm beeps three times with a command	<ul style="list-style-type: none"> a) Low battery 	<ul style="list-style-type: none"> a) Check if AC power is available. If no AC power, then running on batteries and battery voltage must be 23.0 Vdc or higher. Charge batteries or replace batteries
Alarm beeps when running	<ul style="list-style-type: none"> a) Mains not connected, is AC power indicator on rear of operated illuminated? b) Expansion board setting c) Constant pressure to open or close is given 	<ul style="list-style-type: none"> a) Re-connect power to AC supply b) Pre-warning is set to ON c) Constant pressure to OPEN or CLOSED is given
Expansion board function not controlling door	<ul style="list-style-type: none"> a) Defective main board to expansion board wiring b) Incorrect input wiring to expansion board c) Defective expansion board or defective main board 	<ul style="list-style-type: none"> a) Check main board to expansion board wiring. If required, replace wire cable b) Check wiring to all inputs on expansion board c) Replace defective expansion board or defective main board

TROUBLESHOOTING

TROUBLESHOOTING CHART continued...

SYMPTOM	POSSIBLE CAUSES	SOLUTIONS
Switched (SW) Accessory power remaining on	a) In limit setup mode	a) Learn the limits
Accessories connected to Switch (SW) Accessory power not working correctly, turning off, or resetting	a) Normal behavior	a) Move accessory to accessory power "ON"
Accessories connected to Accessory power not working correctly, turning off, or resetting	a) Accessory power protector active b) Defective control board	a) Disconnect all accessory powered devices and measure accessory power voltage (should be 23 – 30 Vdc). If voltage is correct, connect accessories one at a time, measuring accessory voltage after every new connection b) Replace defective control board
Quick Close not working correctly	a) Quick Close setting incorrect b) Interrupt loop detector c) Defective Expansion board	a) Check that Quick Close setting is ON b) Check operation of Interrupt Loop detector c) Replace defective Expansion board
Anti-Tailgating not working correctly	a) Anti-Tail setting incorrect b) Interrupt loop detector c) Defective Expansion board	a) Check that Anti-Tail setting is ON b) Check operation of Interrupt Loop detector c) Replace defective Expansion board
AUX Relay not working correctly	a) AUX Relay setting incorrect b) AUX Relay wiring incorrect c) Defective Expansion board	a) Check AUX Relay switches settings b) Check that wiring is connected to either N.O. and COM or to N.C. and COM c) Set AUX Relay to another setting and test. Replace defective expansion board

SERVICE & REPAIR PARTS

Toroid Transformer
GSD-K204C0211

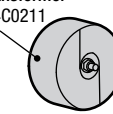

Motor
GSD-K76-36398

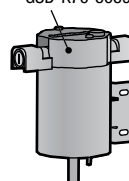

Gear Reducer
GSD-K32-37560-1

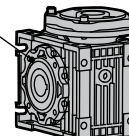

EMI Board 120V/240V
GSD-K76-34728

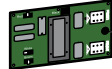

APE Assembly with plastic tray
GSD-K1A6408-2

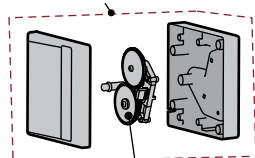

APS Encoder with cable
GSD-K76-34697

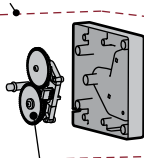

Two 7AH batteries
GSD-K74-30762

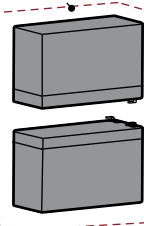

Bridge Rectifier
GSD-K52C0481



Antenna
GSD-K77-36541



Main Control Board
GSD-K1D8389-1CC

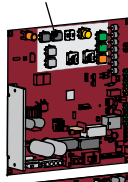

Expansion Board
GSD-K1D8387-1CC

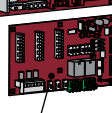

Trolley
GSD-SP-Trolley



Acetyl Sliders
GSD-SP-Sliders



NOT SHOWN

GSD-K94-36540 Wiring Harness with product ID assembly

GSD-K94-34778 Wire harness between main control board and expansion board

GSD-K76-37858 Reset Button with product ID assembly

WIRING DIAGRAM

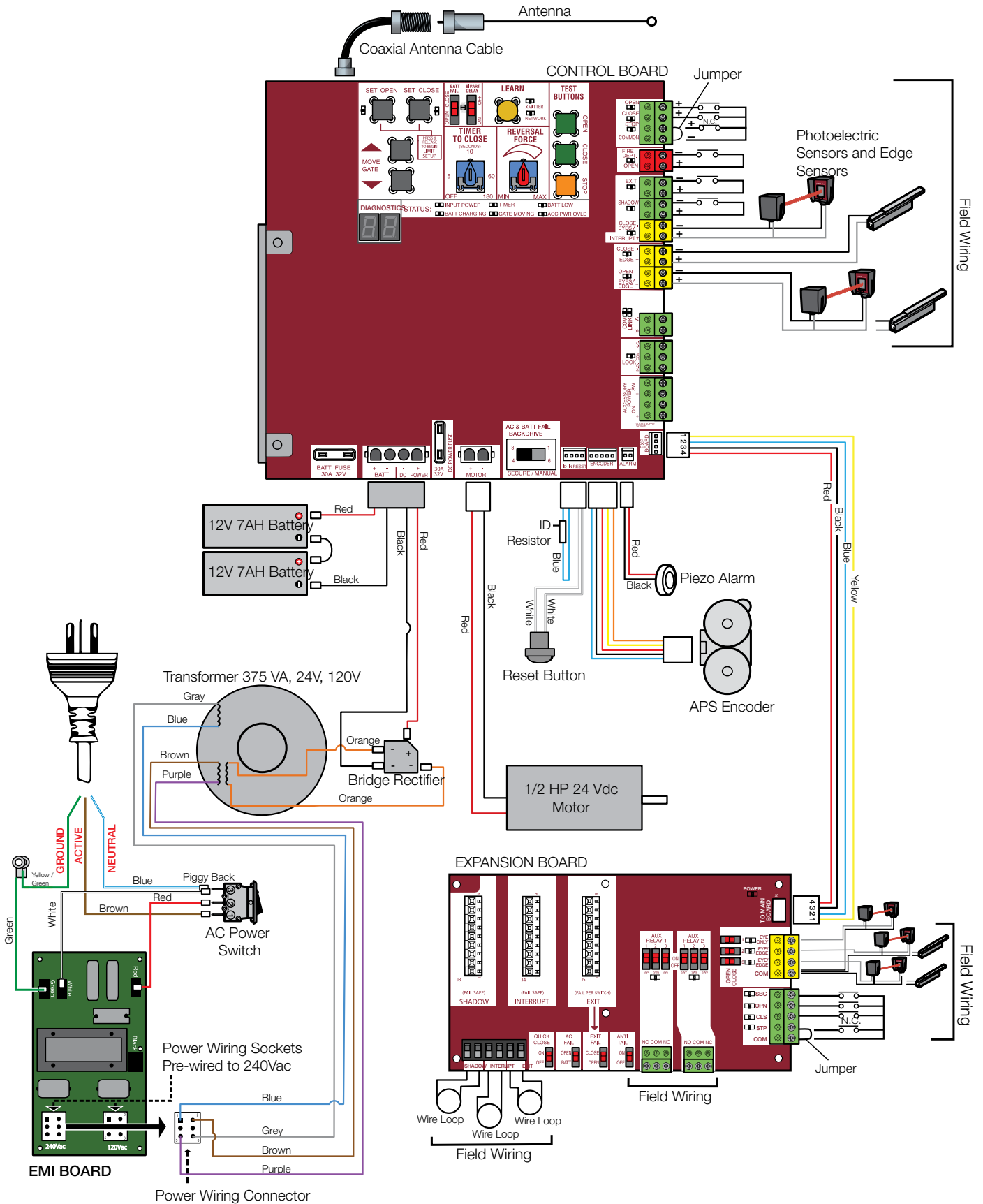

WARNING

To protect against fire and electrocution:
 DISCONNECT power (AC or solar and battery) BEFORE installing or servicing operator.

For continued protection against fire:
 Replace ONLY with fuse of same type and rating.

CHAMBERLAIN LIMITED WARRANTY - S-DRIVE OPERATOR

Chamberlain Australia Pty Limited / Chamberlain New Zealand Limited (Chamberlain) is committed to manufacturing and supplying high quality goods. As part of this commitment, we seek to provide reliable service and support for our goods and are pleased to provide you, the original purchaser, with this Chamberlain Limited Warranty. We also provide the following statement as required by the Australian Consumer Law: In Australia, in addition to your rights under this Chamberlain Limited Warranty, our goods come with guarantees that cannot be excluded under the Australian Consumer Law. You are entitled to a replacement or refund for a major failure and for compensation for any other reasonably foreseeable loss or damage. You are also entitled to have the goods repaired or replaced if the goods fail to be of acceptable quality and the failure does not amount to a major failure.

Chamberlain's S-Drive Warranty

Chamberlain warrants to the original purchaser of the Grifco S-Drive product (Operator) that:

- 1 The S-Drive operator (including electric motor) is free from defects in materials and workmanship for a period of 2 years from the date of purchase or 100,000 cycles (whichever ever comes first). Cycles can be determined by following the instructions in the manual.
- 2 During the applicable Chamberlain Warranty period, if you are concerned that the Operator or electric motor may be defective, call our service centre on the toll free number below before removing the operator and a Chamberlain technician will diagnose the problem. Once the problem has been diagnosed, subject to your rights under the Australian Consumer Law with respect to major failures,

Chamberlain will provide you with:

- 1 parts for "do-it-yourself" repairs; or
- 2 shipping instructions for a factory repair or replacement.

If a factory repair or replacement is required, provided the defective part or Operator is returned to Chamberlain well-packaged and in accordance with Chamberlain's shipping instructions,

Chamberlain will, subject to your rights under the Australian Consumer Law with respect to major failures:

- 1 in relation to the Operator, repair or, at its option where permissible, replace any defective part or Operator and return it to you at no cost; and
- 2 Where the Operator has been installed by an authorised installer, you must call them for prompt on-site service. Chamberlain will furnish replacement parts free of charge through the authorised installer. A service fee for on-site service may apply. Repairs and replacement parts provided under this Chamberlain Limited Warranty are provided free of charge and are warranted for the remaining portion of the original warranty period. This Chamberlain Limited Warranty provides benefits which are in addition to your other rights and remedies as a consumer.

Exclusions

If our service centre determines that a warranty claim has been made in respect of a failure or defect arising under or out of any exclusion detailed below such that the claim is not covered under this Chamberlain Limited Warranty, we may, subject to your other rights and remedies as a consumer, charge you a fee to repair, replace and/or return the Operator to you.

This Chamberlain Limited Warranty does not cover any failure of, or defect in, the Operator due to:

- 1 non-compliance with the instructions regarding installation, operation, maintenance and testing of the Operator or of any product with which the Operator is used;
- 2 any attempt by a person other than an authorised installer to change settings, repair, dismantle, reinstall or move the Operator to another location once it has been installed;
- 3 tampering, neglect, abuse, wear and tear, accident, electrical storm, excessive use or conditions other than normal commercial use;
- 4 use of the Operator in conjunction with controls which have not been supplied, or pre-approved, by Chamberlain;
- 5 problems with, or relating to, the commercial door or commercial door hardware, including but not limited to the door springs, door rollers, door alignment, hinges, guides, slats and drums; or
- 6 problems caused by electrical faults.

This Chamberlain Limited Warranty excludes perishable components such as acetyl sliders and batteries.

If this Chamberlain Limited Warranty does not apply, you may have rights available to you under the Australian Consumer Law.

Liability – Australia only

Except as set out in the Australian Consumer Law (being Schedule 2 of the Competition and Consumer Act 2010) (as amended, consolidated or replaced):

- 1 all other guarantees, warranties and representations in relation to the Operator or its supply are excluded to the extent that Chamberlain can lawfully exclude them; and
- 2 under no circumstances will Chamberlain be liable for consequential, incidental or special damages arising in connection with the use, or inability to use, the Operator, other than those which were reasonably foreseeable as liable to result from the failure.

Liability – New Zealand only

Except as set out in the Fair Trading Act 1986 and the Consumer Guarantees Act 1993 (as amended, consolidated or replaced):

- 1 all other guarantees, warranties and representations in relation to the Operator or its supply are excluded to the extent that Chamberlain can lawfully exclude them; and
- 2 under no circumstances will Chamberlain be liable for consequential, incidental or special damages arising in connection with the use, or inability to use, the Operator, other than those which were reasonably foreseeable as liable to result from the failure.

Note

We request that you retain your sales docket or invoice as proof-of-purchase and attach it to this manual to enable you to establish the date of purchase in the unlikely event of a warranty service being required. Chamberlain reserves the right to change the design and specifications of the Unit without prior notification. Some features or accessories of the Unit may not be available in certain markets or areas. Please check with your distributor.

Chamberlain service centre contact details Australia

Phone toll free 1800 474 326

Fax toll free 1800 888 121

Unit 1, 75 Epping Road North Ryde, NSW 2113

Email customerservice@chamberlainanz.com

New Zealand

Auckland phone 09 477 2823

Phone toll free 0800 653 667

Fax toll free 0800 653 663

Website www.grifco.com.au or www.grifco.co.nz